

### Using These Measurements

This document contains the approximate room measurements for Pittman Hall. We recommend that it be viewed in Adobe Acrobat, which can be downloaded at Adobe's website, [www.adobe.com/reader](http://www.adobe.com/reader).

Because there are many configurations available for every area, these layouts and measurements should be seen as general guidelines. All measurements and drawings are made to scale, however the drawings may not reflect all aspects of every room. There may be architectural features that do not allow furniture to fit into a space. We recommend saving all receipts for purchased furnishings just in case they won't fit.

The Housing and Residence Life main office is available for questions at [reslife@samford.edu](mailto:reslife@samford.edu) or (205)726-2956. We will do our best to provide any details or measurements we currently possess but we cannot promise to provide answers to all possible questions. Visiting rooms before move-in is not allowed.

### Finding Your Room Configuration

In order to find the configuration for your room, we recommend you utilize the Find command built into most PDF viewers. In Adobe Acrobat, use your mouse to click on Find under the Edit menu. You can also press Control+F if you use Windows or Command+F if you use a Mac.

If you were searching for Pittman 302, type in "302" and hit Enter. It should take you to the page that contains the measurements for your room. You can verify this by looking at the bottom left of the page under the "Configuration Notes"; it will list all rooms which that configuration is applicable to.

### Other Tips

All Samford owned furniture must stay in the room. Residents are welcome to bring in their own furniture and rearrange provided furniture but the Samford owned furniture may not leave the room or be stored elsewhere. Furniture may not be in the same layout as the drawing at move-in.

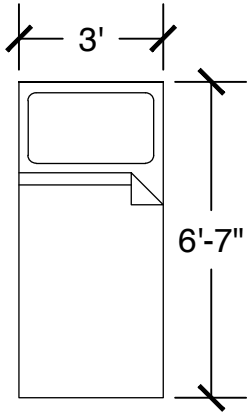

Standard Bed (x2)

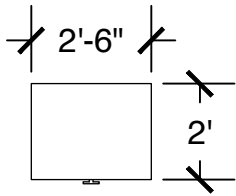

Dresser (x2)

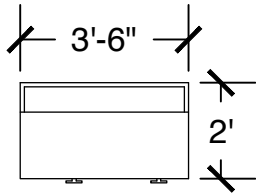

Desk w/ Hutch (x2)

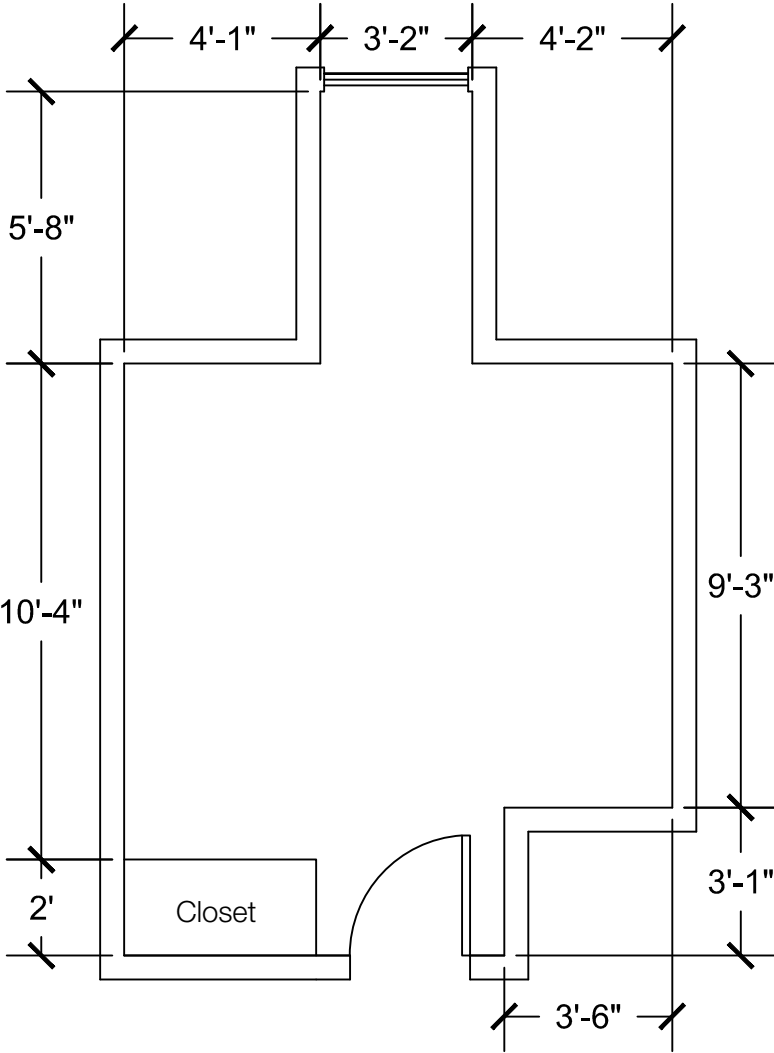

**Configuration Notes:**

Applicable to Pittman 413 and 419

All drawings are 1/4"=1'-0" scale

Dimensions are meant to be general figures and may not be exact

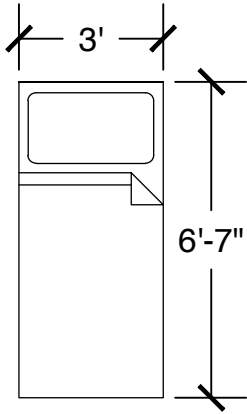

Standard Bed (x2)

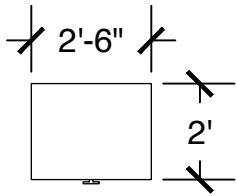

Dresser (x2)

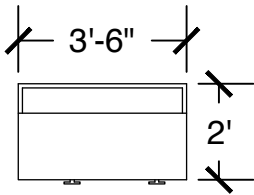

Desk w/ Hutch (x2)

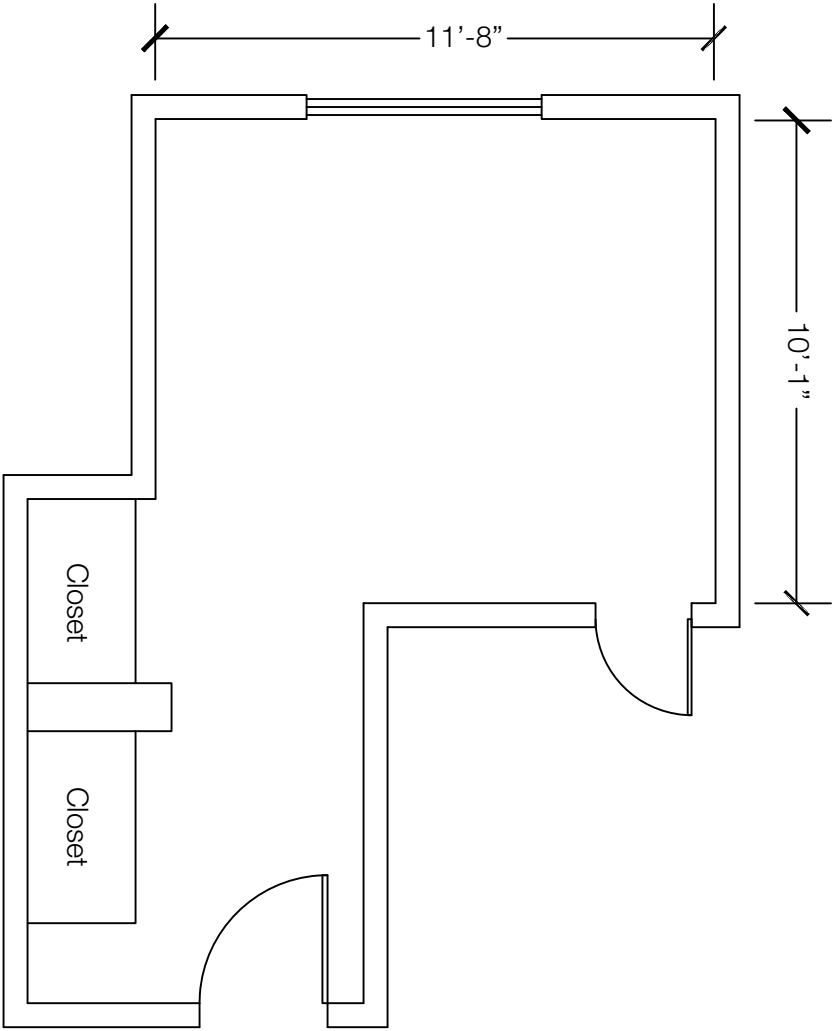

**Configuration Notes:**

Applicable to Pittman 328  
 All drawings are 1/4"=1'-0" scale  
 Dimensions are meant to be general figures and may not be exact

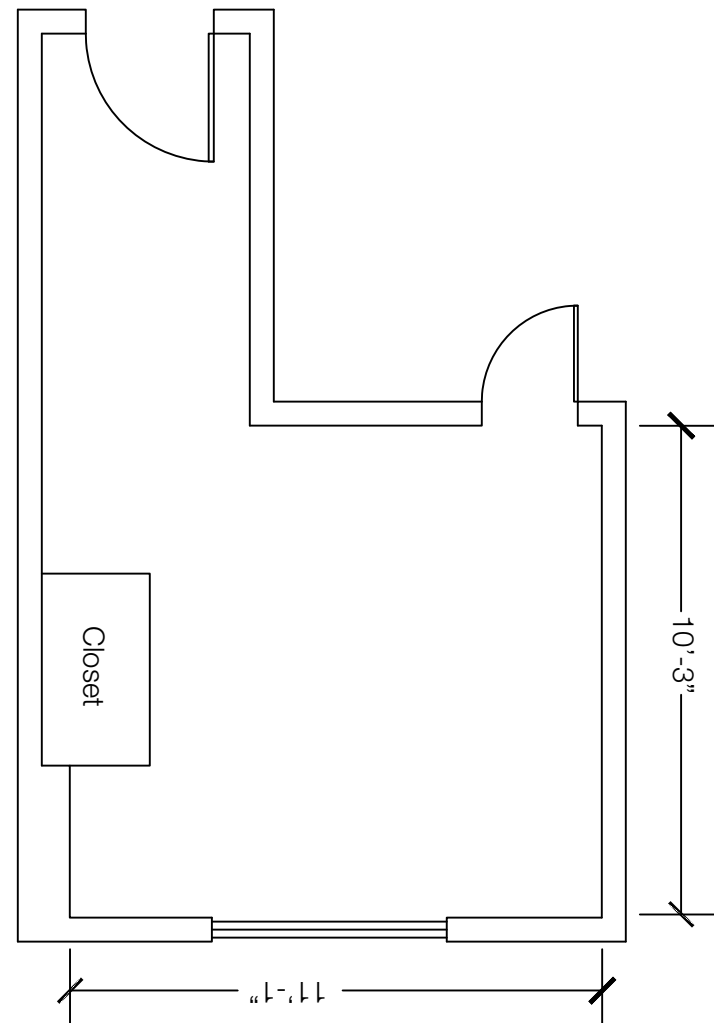
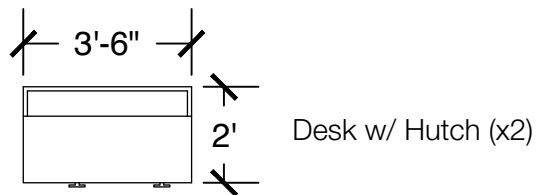
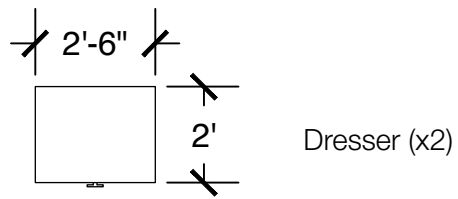
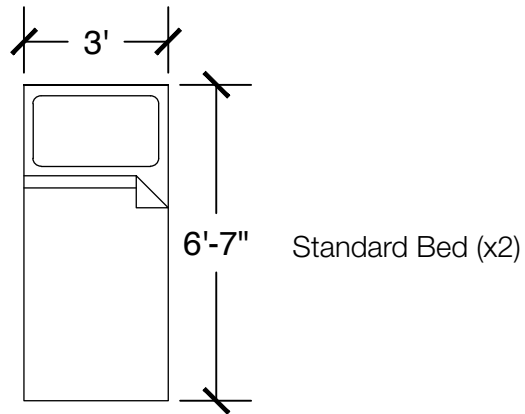

**Configuration Notes:**

Applicable to Pittman 221 and 321

All drawings are 1/4"=1'-0" scale

Dimensions are meant to be general figures and may not be exact

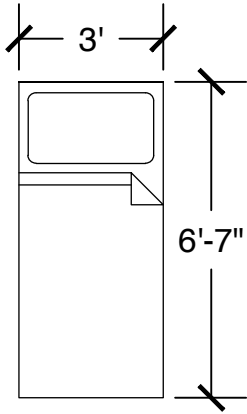

Standard Bed (x2)

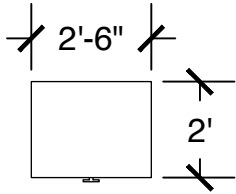

Dresser (x2)

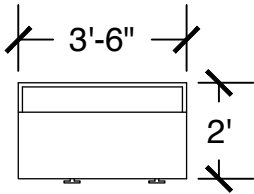

Desk w/ Hutch (x2)

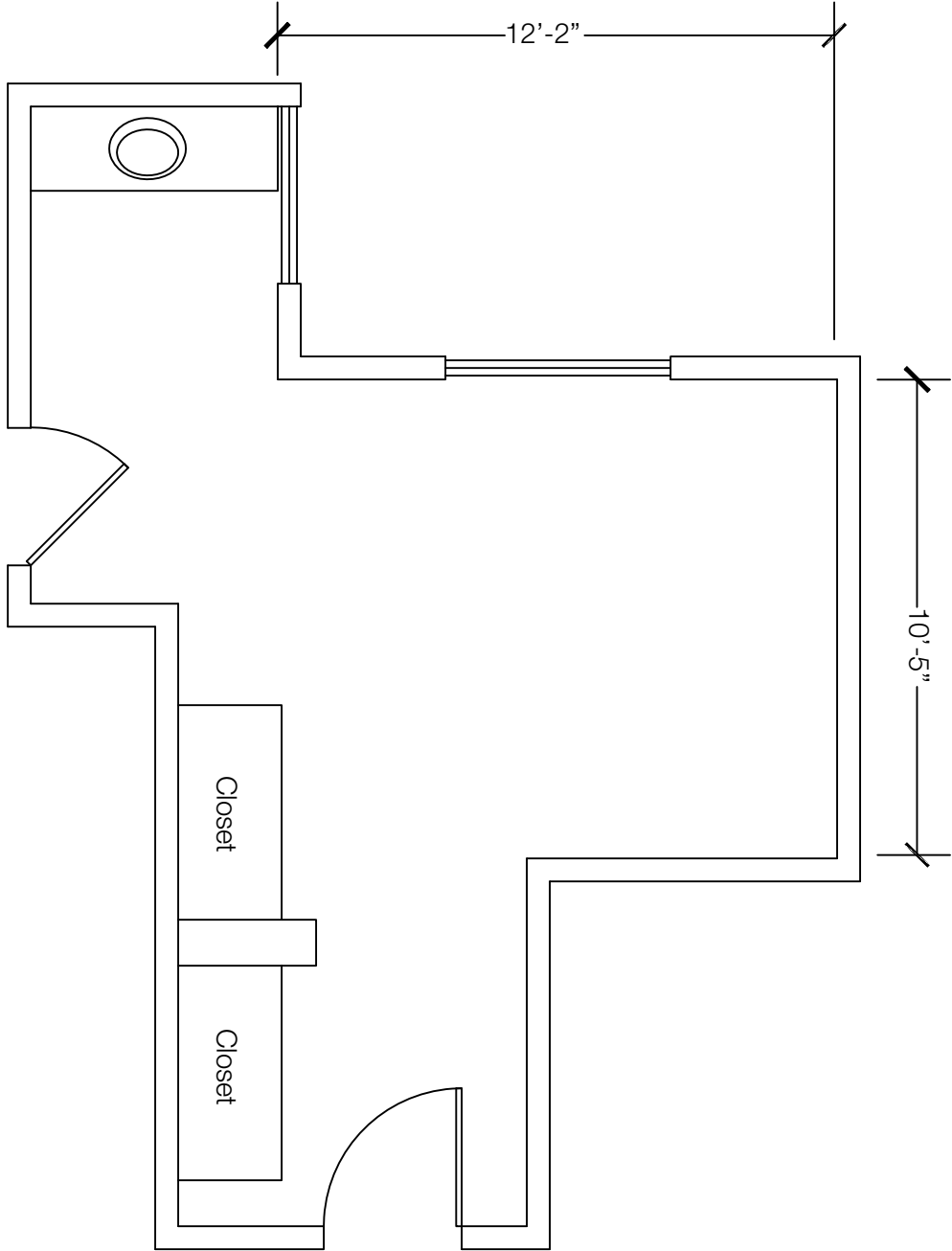

**Configuration Notes:**

Applicable to Pittman 122  
 All drawings are 1/4"=1'-0" scale  
 Dimensions are meant to be general figures and may not be exact

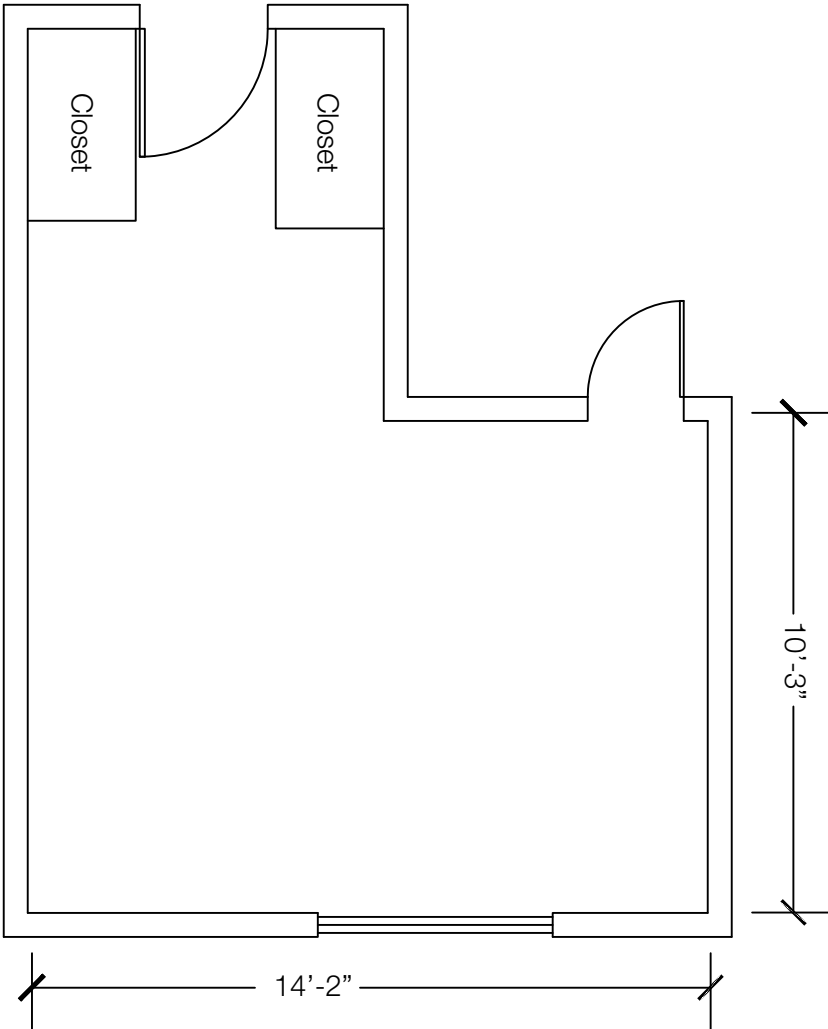
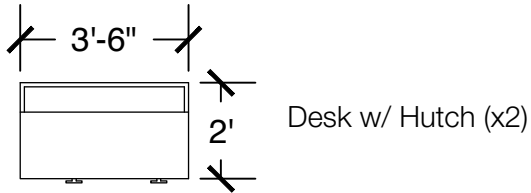
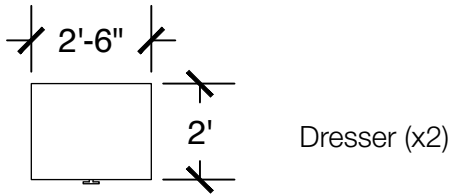
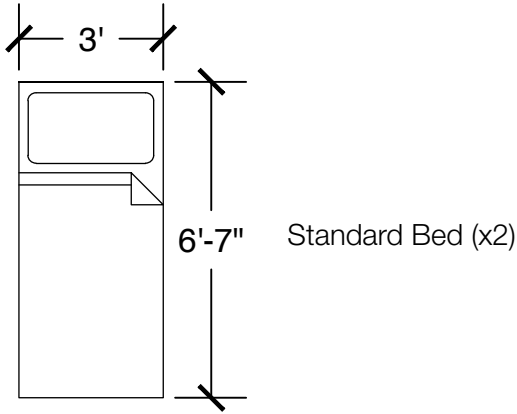

**Configuration Notes:**

Applicable to Pittman 121  
 All drawings are 1/4"=1'-0" scale  
 Dimensions are meant to be general figures and may not be exact

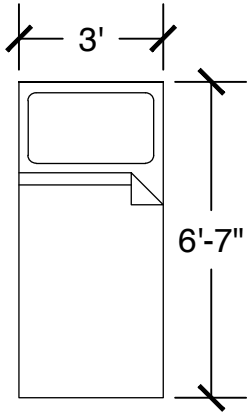

Standard Bed (x2)

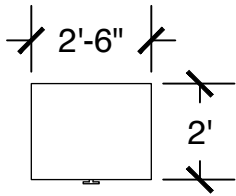

Dresser (x2)

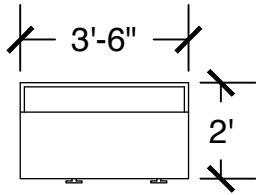

Desk w/ Hutch (x2)

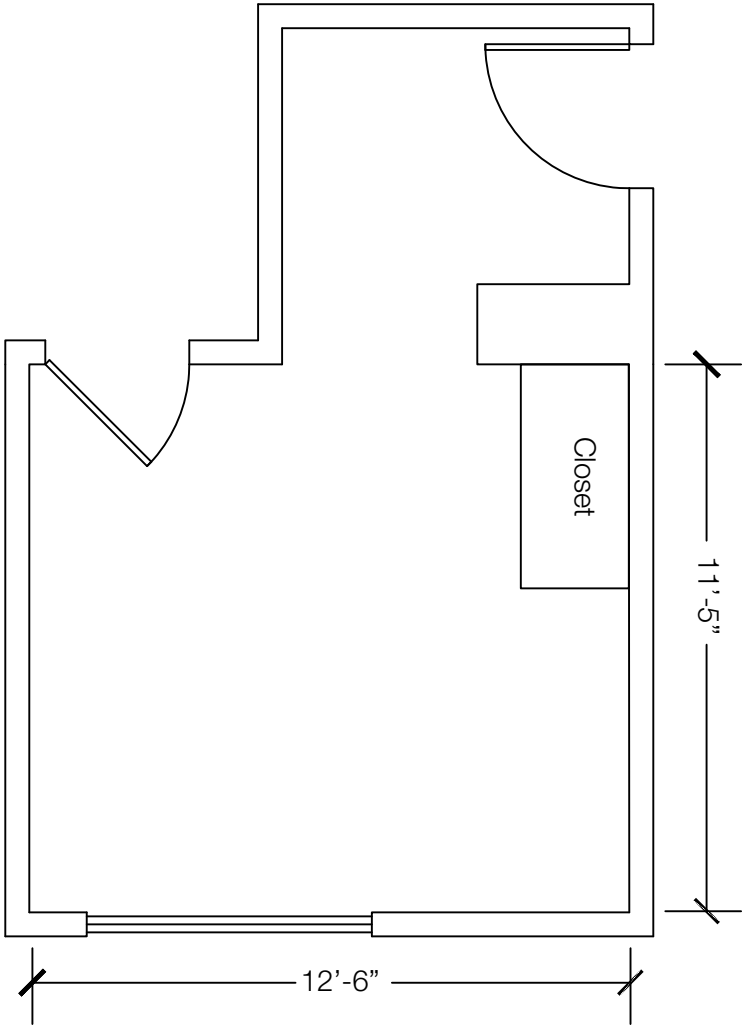

**Configuration Notes:**

Applicable to Pittman 117  
 All drawings are 1/4"=1'-0" scale  
 Dimensions are meant to be general figures and may not be exact

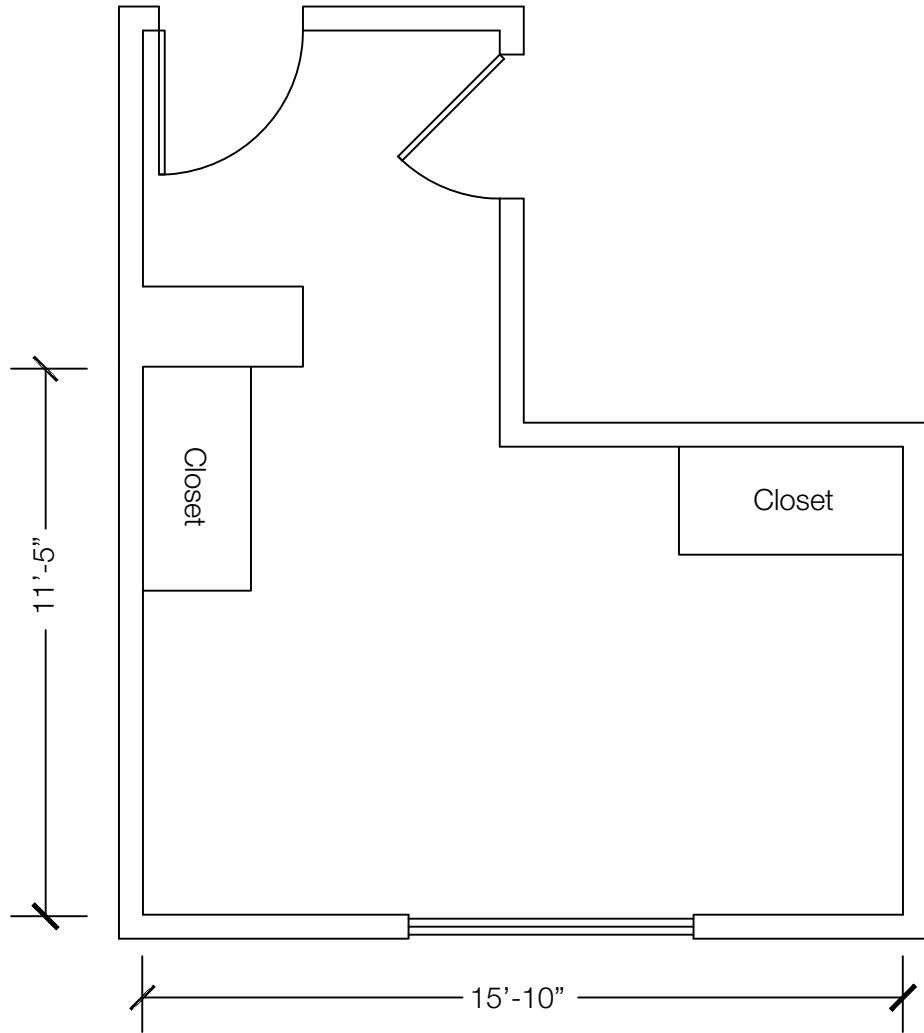
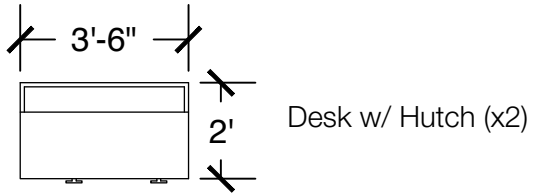
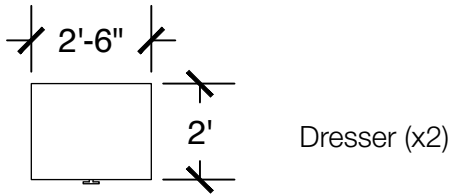
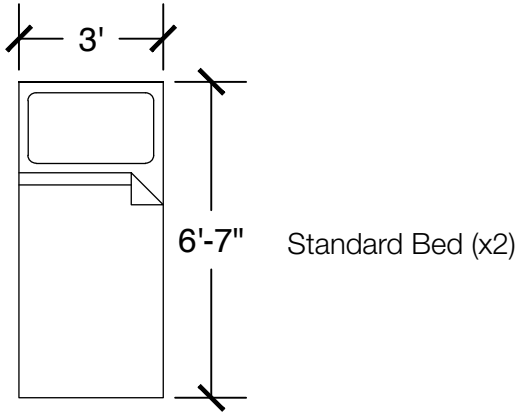

**Configuration Notes:**

Applicable to Pittman 115  
 All drawings are 1/4"=1'-0" scale  
 Dimensions are meant to be general figures and may not be exact



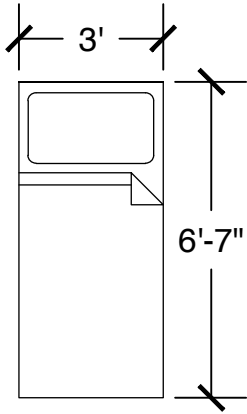

Standard Bed (x2)

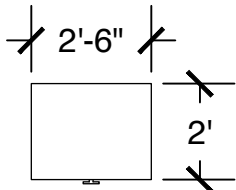

Dresser (x2)

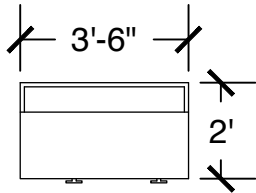

Desk w/ Hutch (x2)

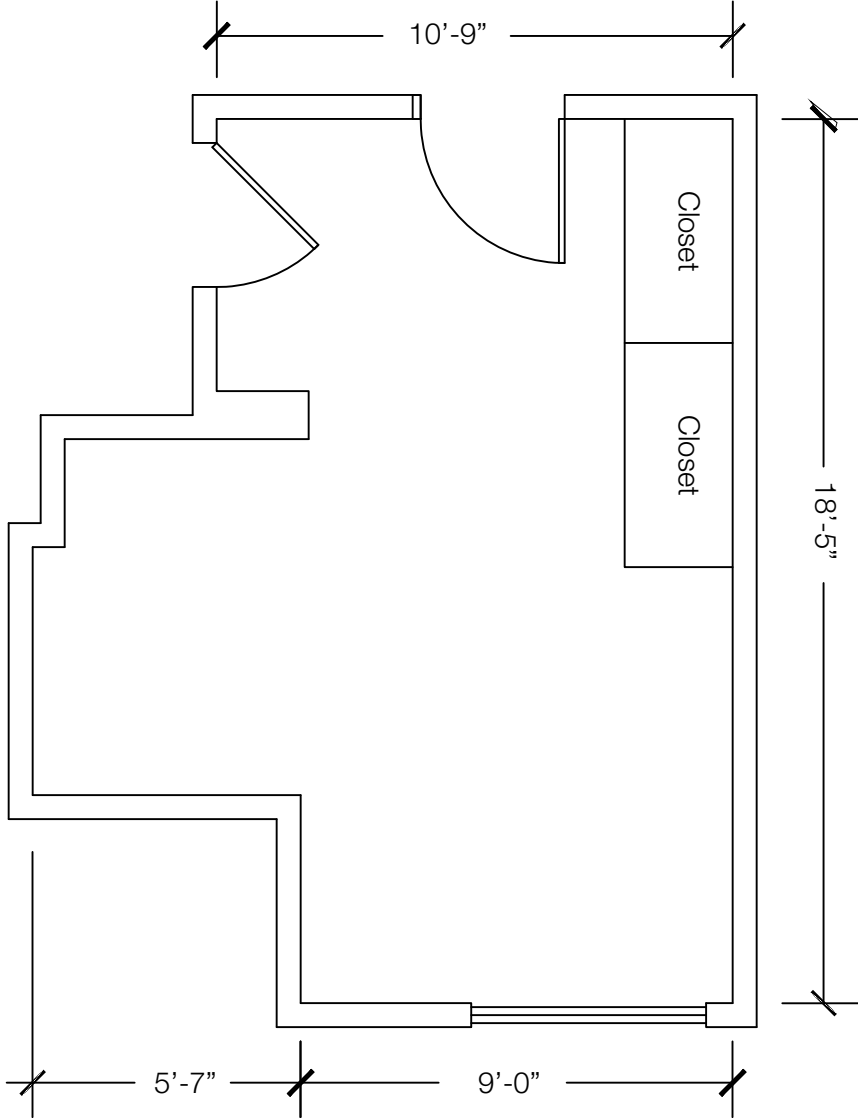

**Configuration Notes:**

Applicable to Pittman 113  
 All drawings are 1/4"=1'-0" scale  
 Dimensions are meant to be general figures and may not be exact

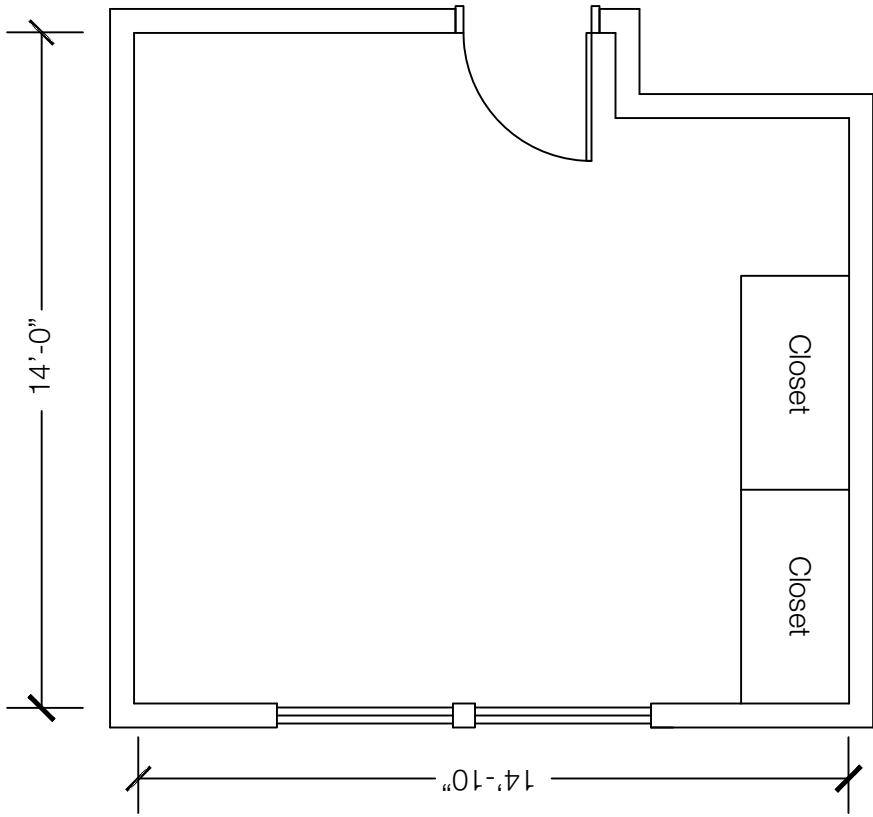
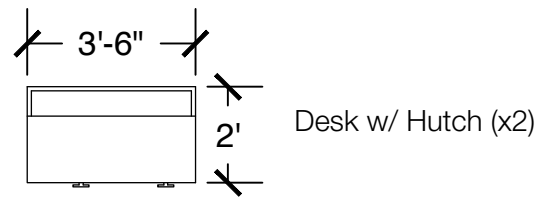
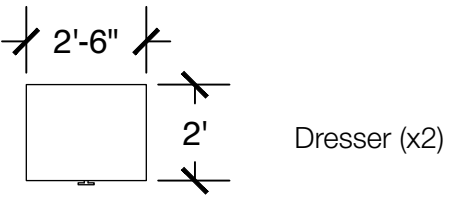
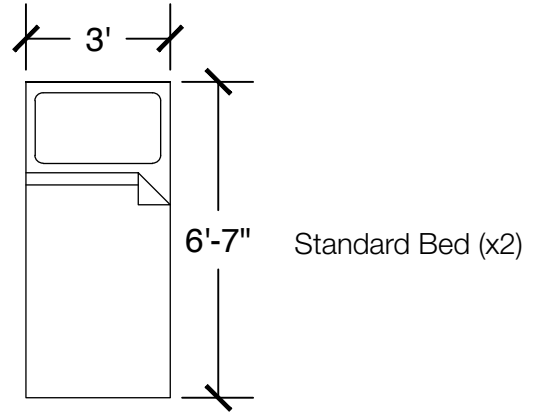

**Configuration Notes:**  
 Applicable to Pittman 425  
 All drawings are 1/4"=1'-0" scale  
 Dimensions are meant to be general figures and may not be exact

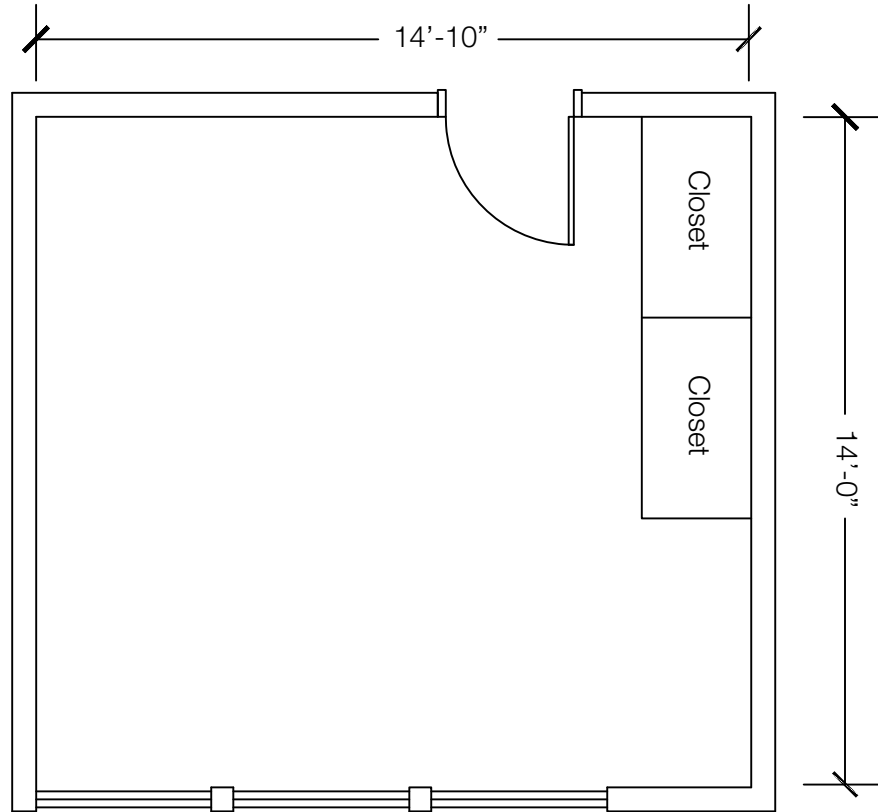
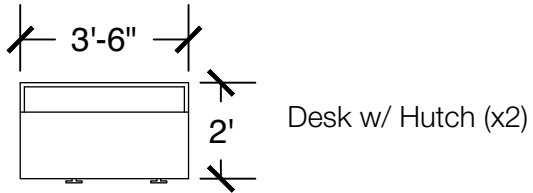
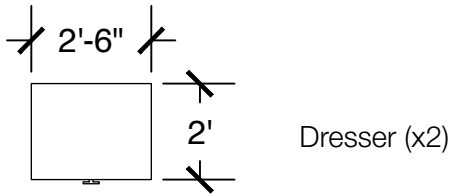
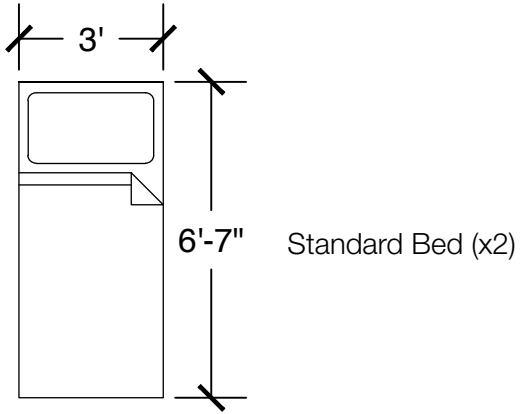

**Configuration Notes:**

Applicable to Pittman 423  
All drawings are 1/4"=1'-0" scale  
Dimensions are meant to be general figures and may not be exact

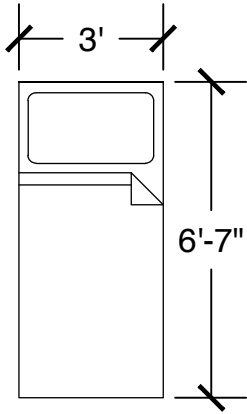

Standard Bed (x2)

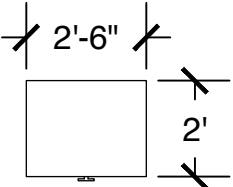

Dresser (x2)

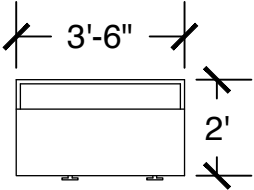

Desk w/ Hutch (x2)

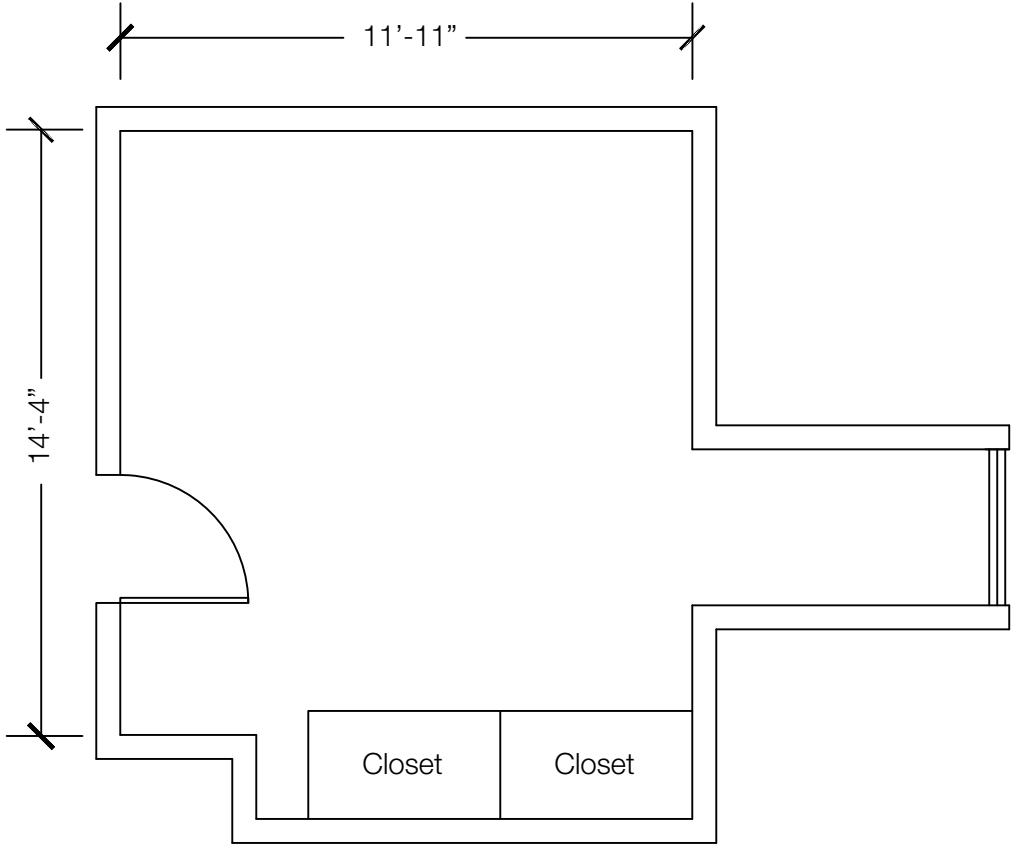

**Configuration Notes:**

Applicable to Pittman 422  
 All drawings are 1/4"=1'-0" scale  
 Dimensions are meant to be general figures and may not be exact

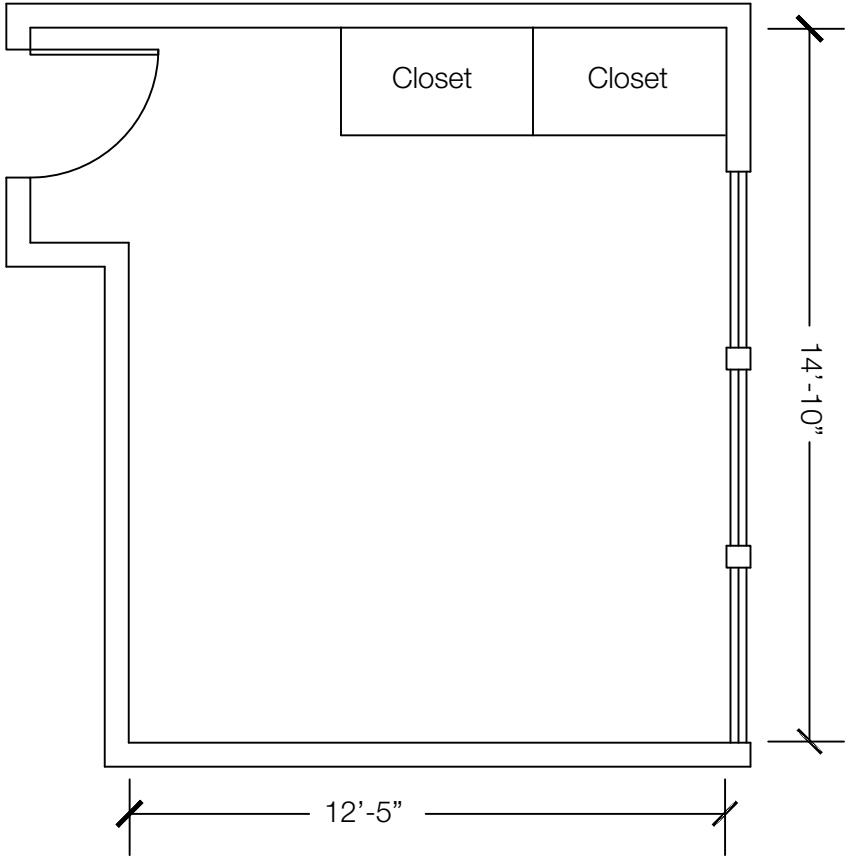
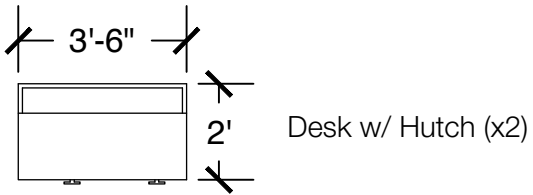
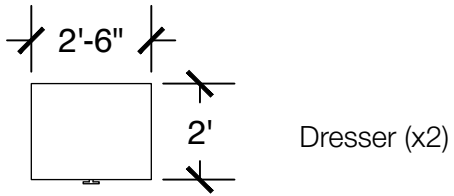
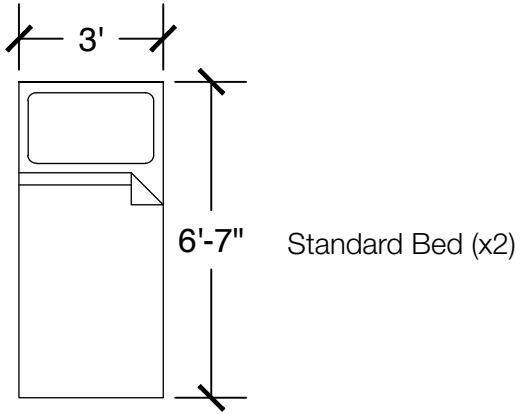

**Configuration Notes:**

Applicable to Pittman 401  
All drawings are 1/4"=1'-0" scale  
Dimensions are meant to be general figures and may not be exact

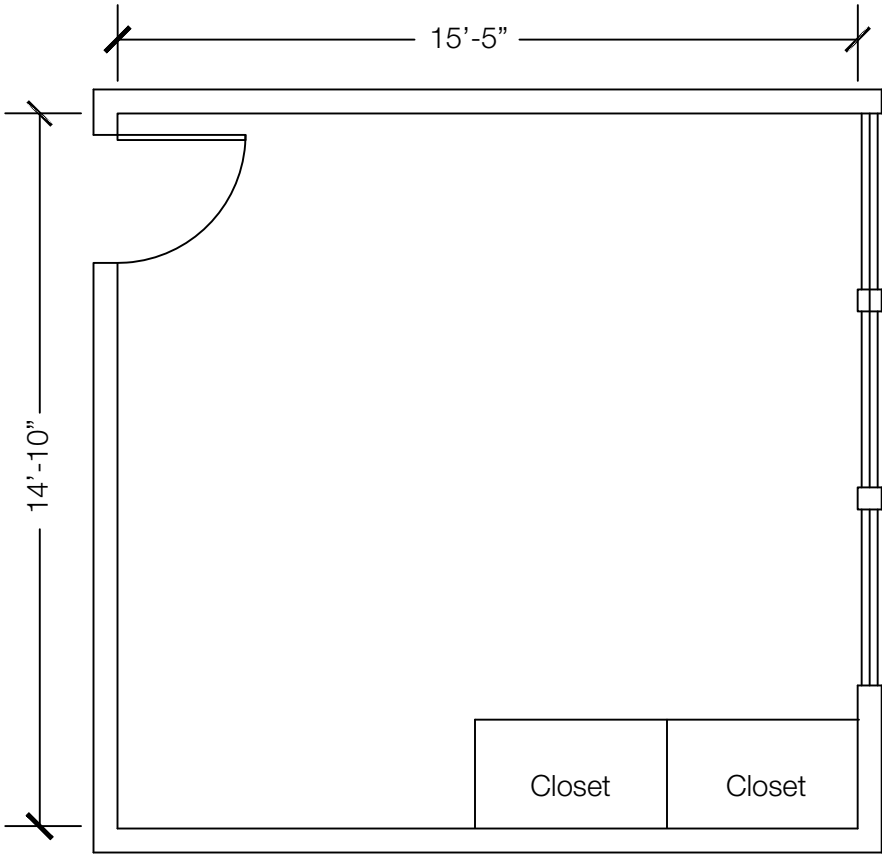
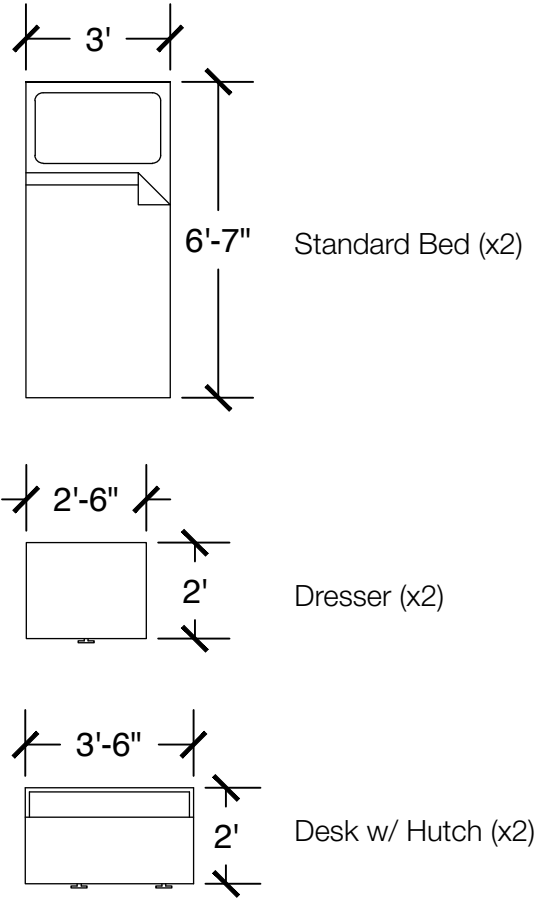

**Configuration Notes:**

Applicable to Pittman 403  
 All drawings are 1/4"=1'-0" scale  
 Dimensions are meant to be general figures and may not be exact

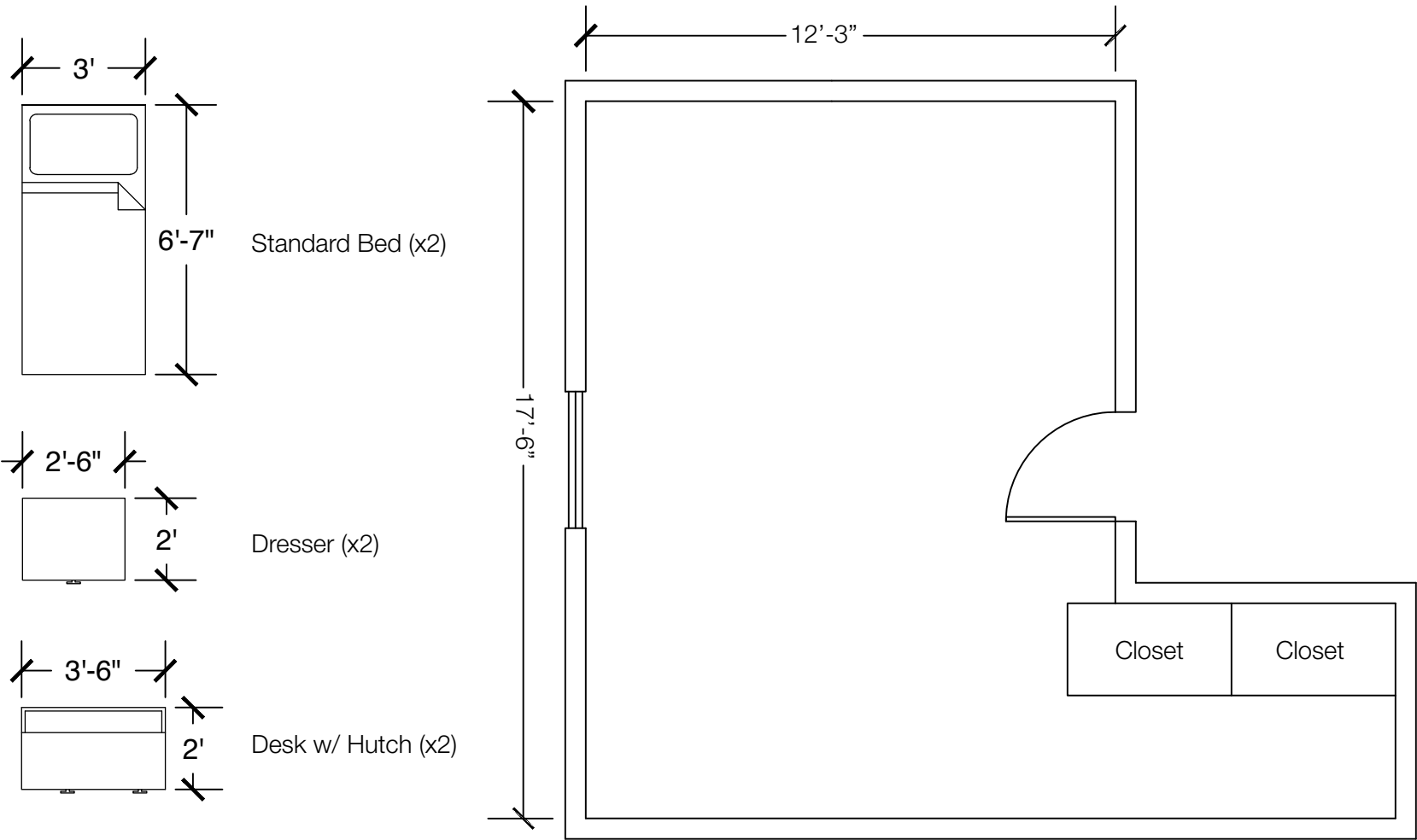

**Configuration Notes:**

Applicable to Pittman 406  
 All drawings are 1/4"=1'-0" scale  
 Dimensions are meant to be general figures and may not be exact

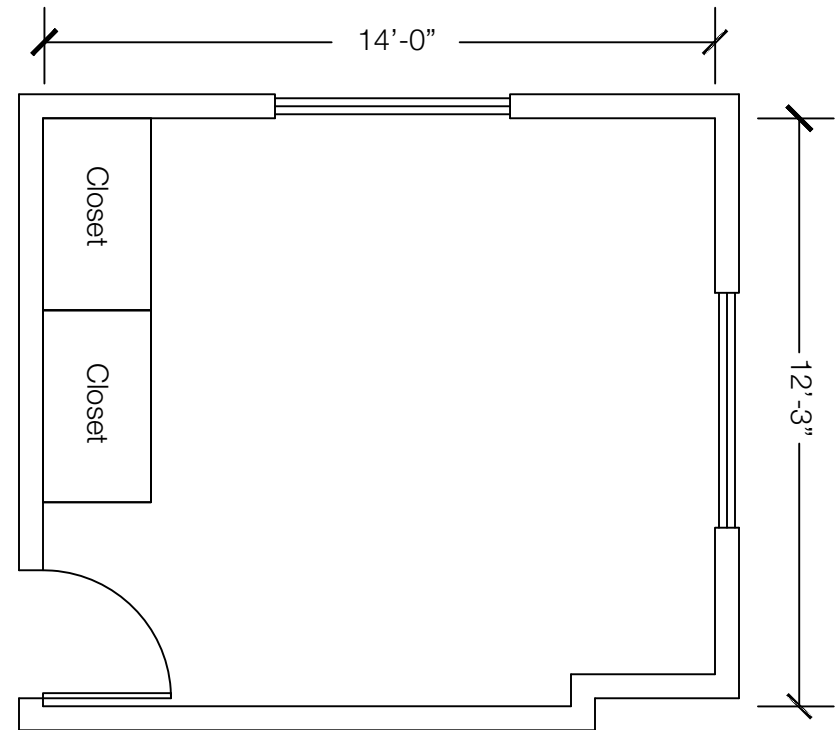
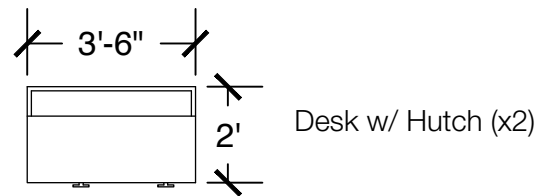
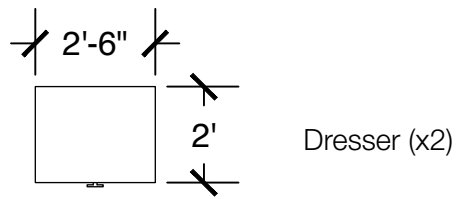
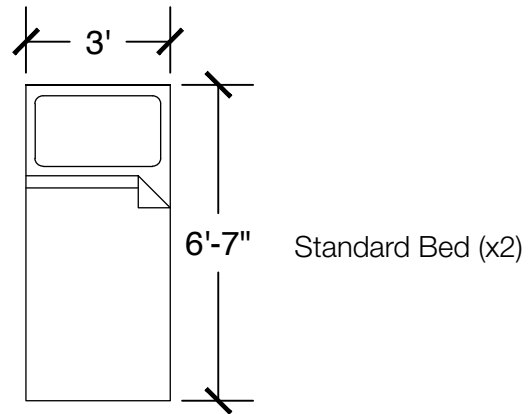

**Configuration Notes:**

Applicable to Pittman 127, 128, 227, 228, 327, and 334

All drawings are 1/4"=1'-0" scale

Dimensions are meant to be general figures and may not be exact



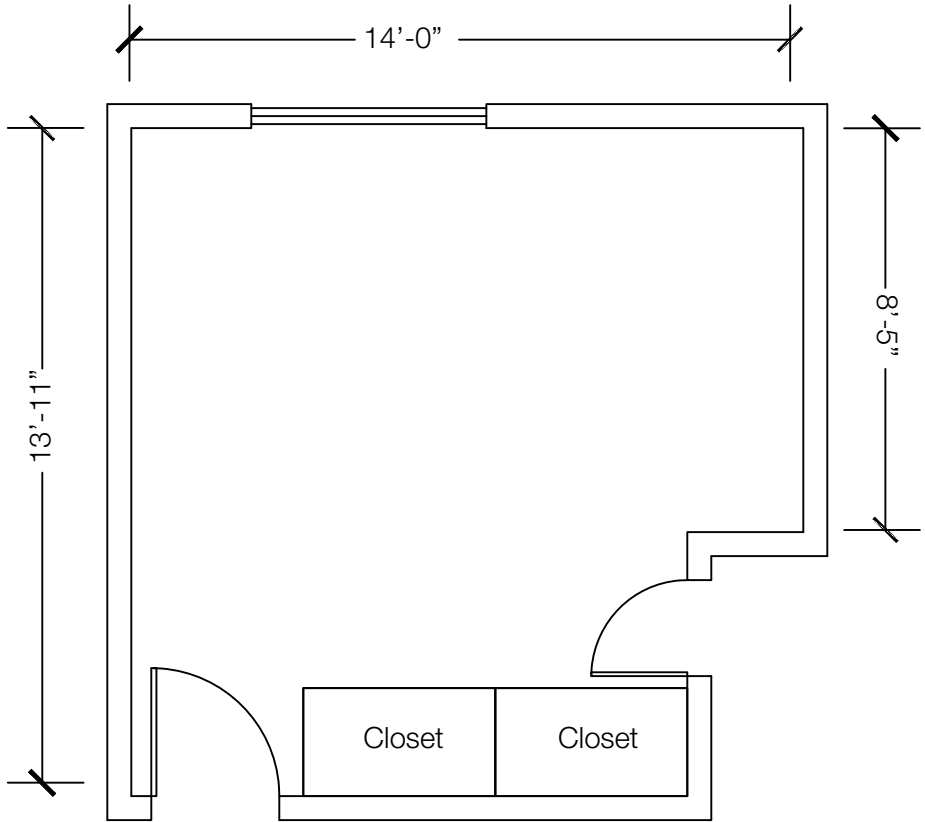
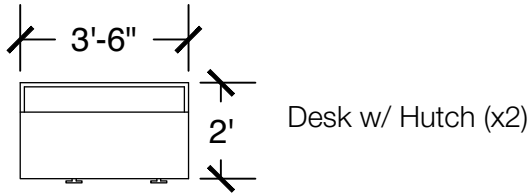
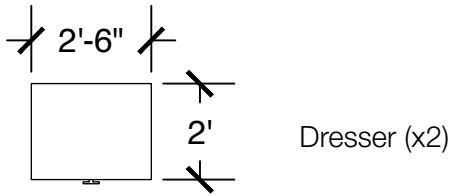
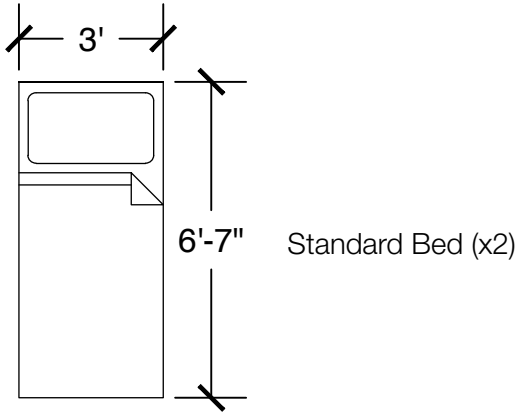

**Configuration Notes:**

Applicable to Pittman 125, 126, 225, 226, 325, and 332  
 All drawings are 1/4"=1'-0" scale  
 Dimensions are meant to be general figures and may not be exact

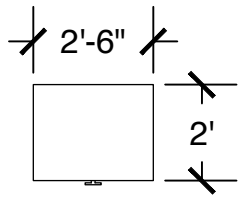
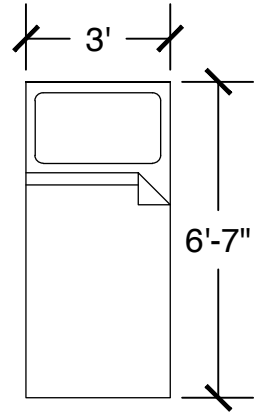

Dresser (x2)

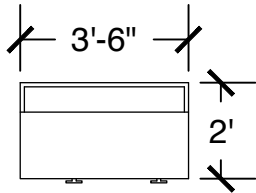

Desk w/ Hutch (x2)

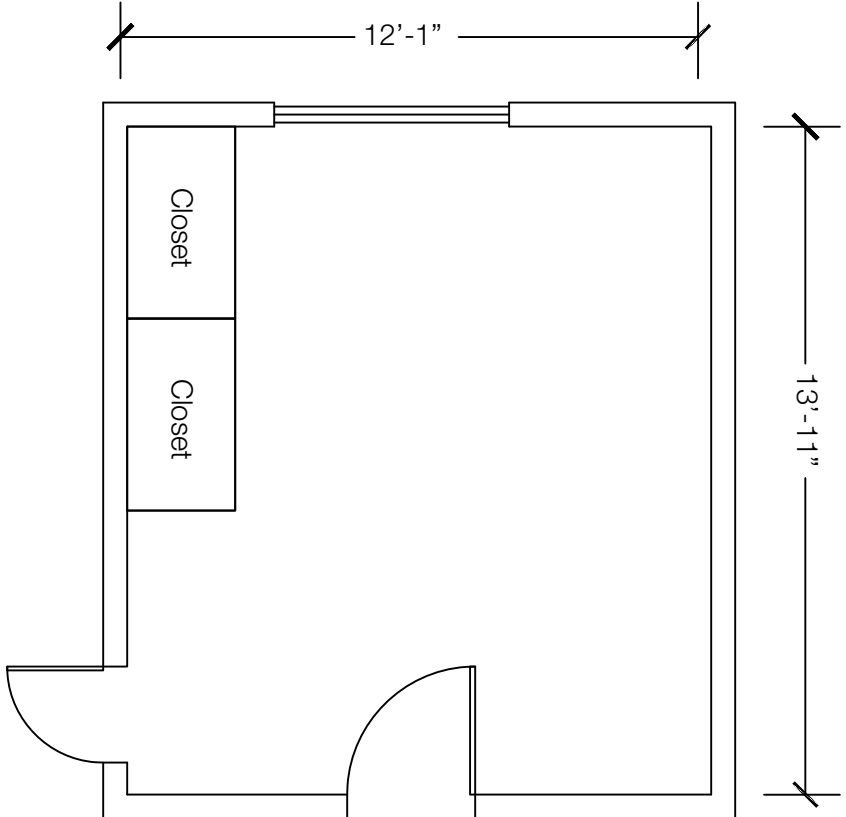

**Configuration Notes:**

Applicable to Pittman 123, 124, 223, 224, 323, and 330  
 All drawings are 1/4"=1'-0" scale  
 Dimensions are meant to be general figures and may not be exact

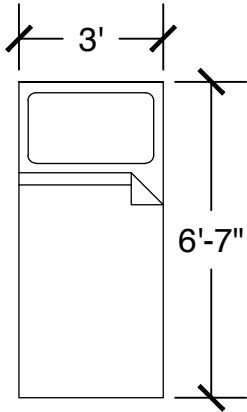

Standard Bed (x2)

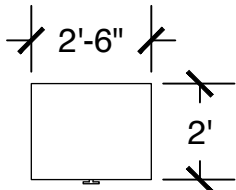

Dresser (x2)

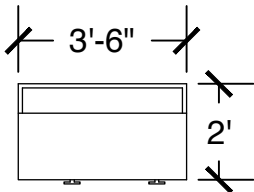

Desk w/ Hutch (x2)

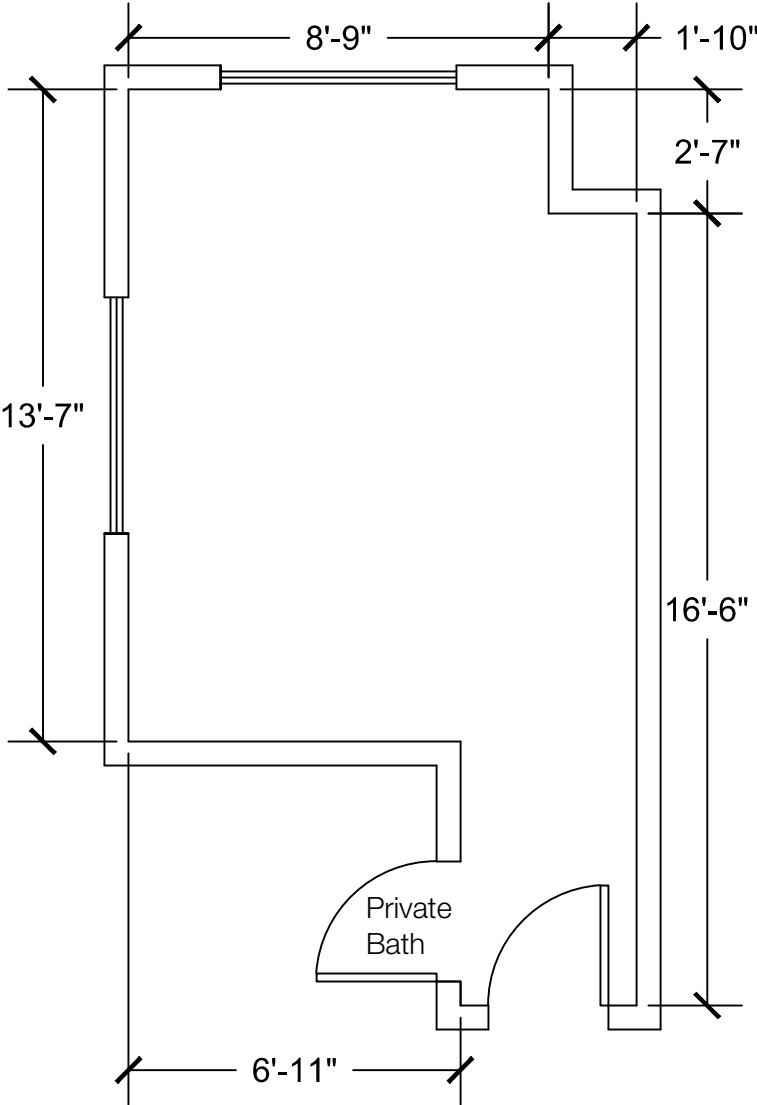

**Configuration Notes:**

Applicable to Pittman 220  
 All drawings are 1/4"=1'-0" scale  
 Dimensions are meant to be general figures and may not be exact

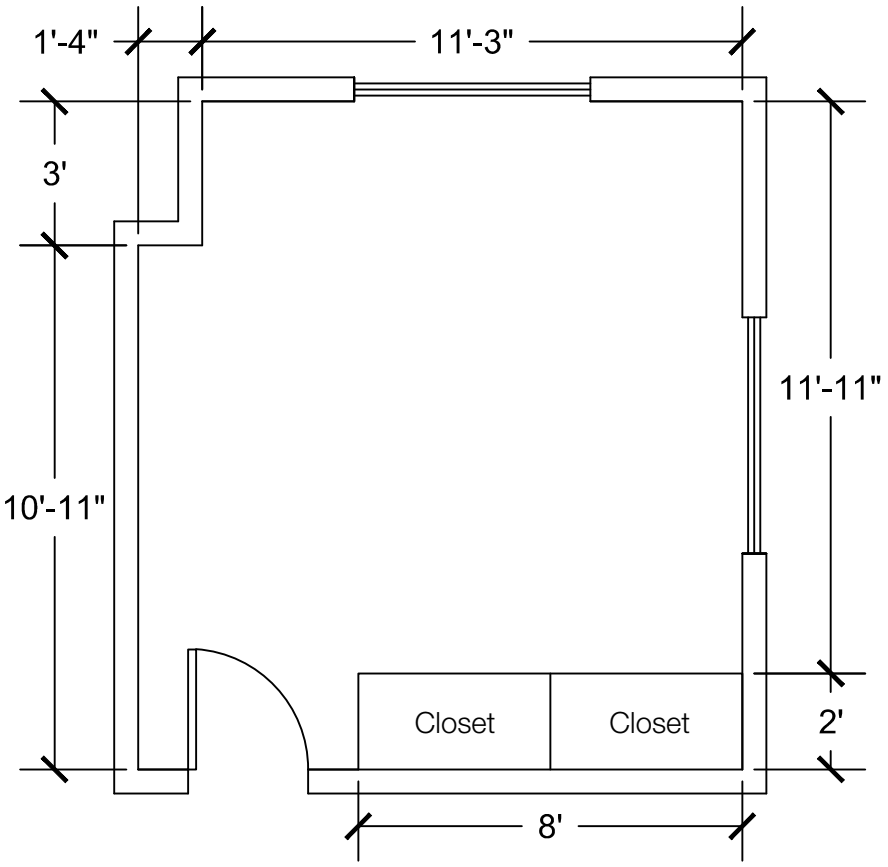
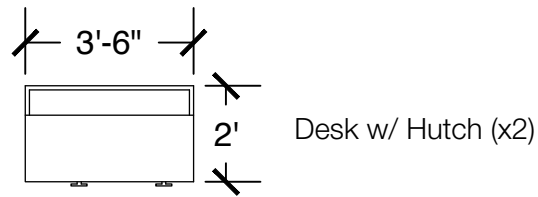
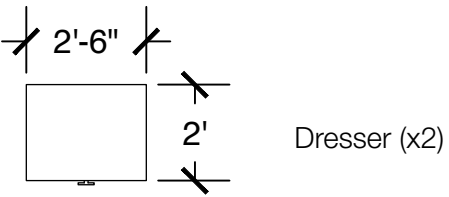
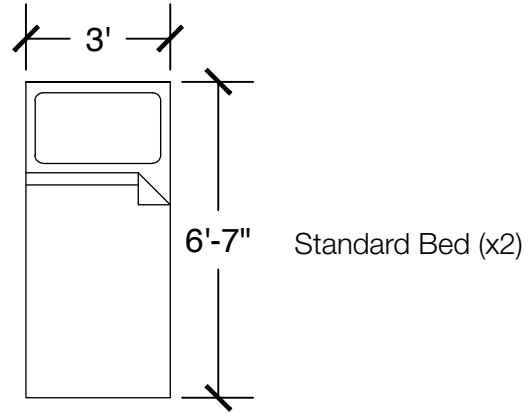

**Configuration Notes:**

Applicable to Pittman 101, 102, 201, 202, 301, and 302  
 All drawings are 1/4"=1'-0" scale  
 Dimensions are meant to be general figures and may not be exact

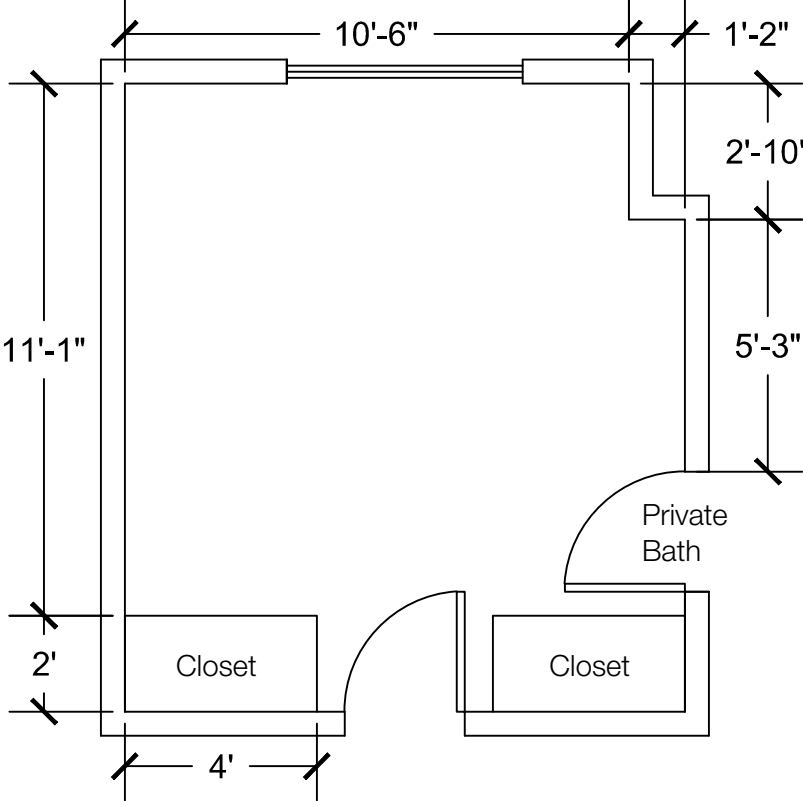
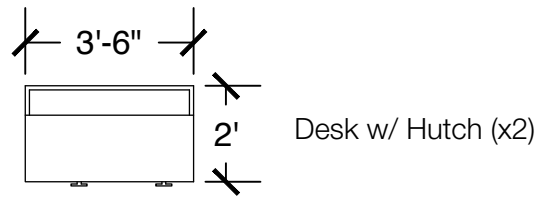
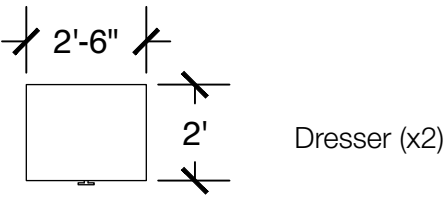
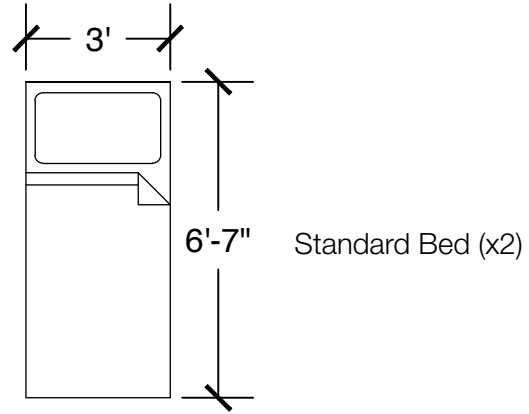

**Configuration Notes:**  
 Applicable to Pittman 103, 104, 105, 106, 203, 204, 205, 206, 303, 304, 305, and 306  
 All drawings are 1/4"=1'-0" scale  
 Dimensions are meant to be general figures and may not be exact

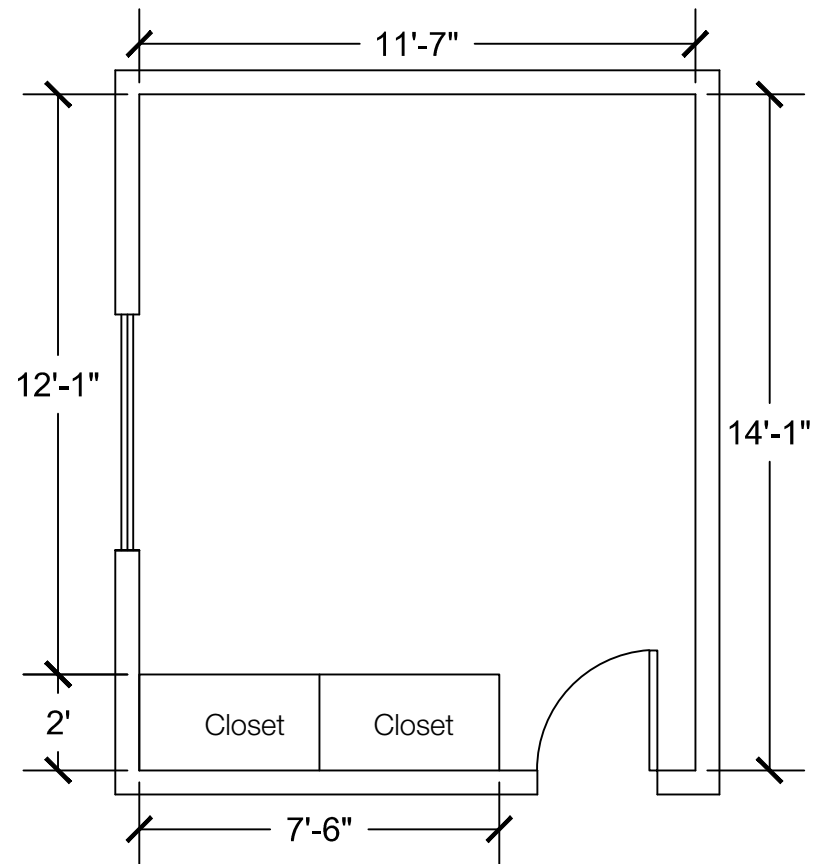
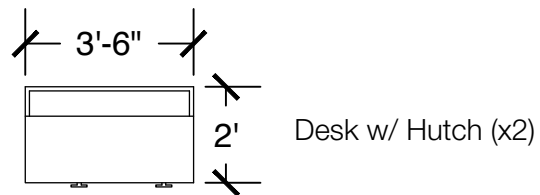
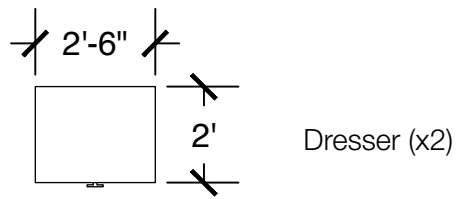
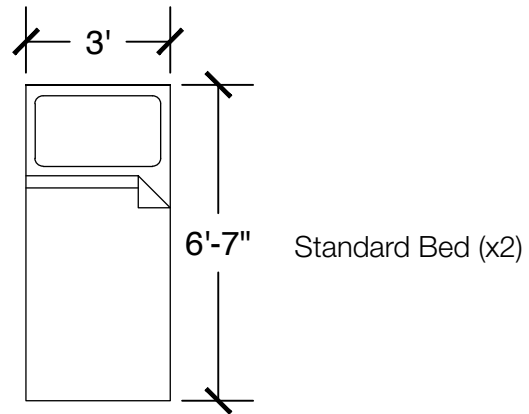

**Configuration Notes:**

Applicable to Pittman 108, 208, and 308

All drawings are 1/4"=1'-0" scale

Dimensions are meant to be general figures and may not be exact

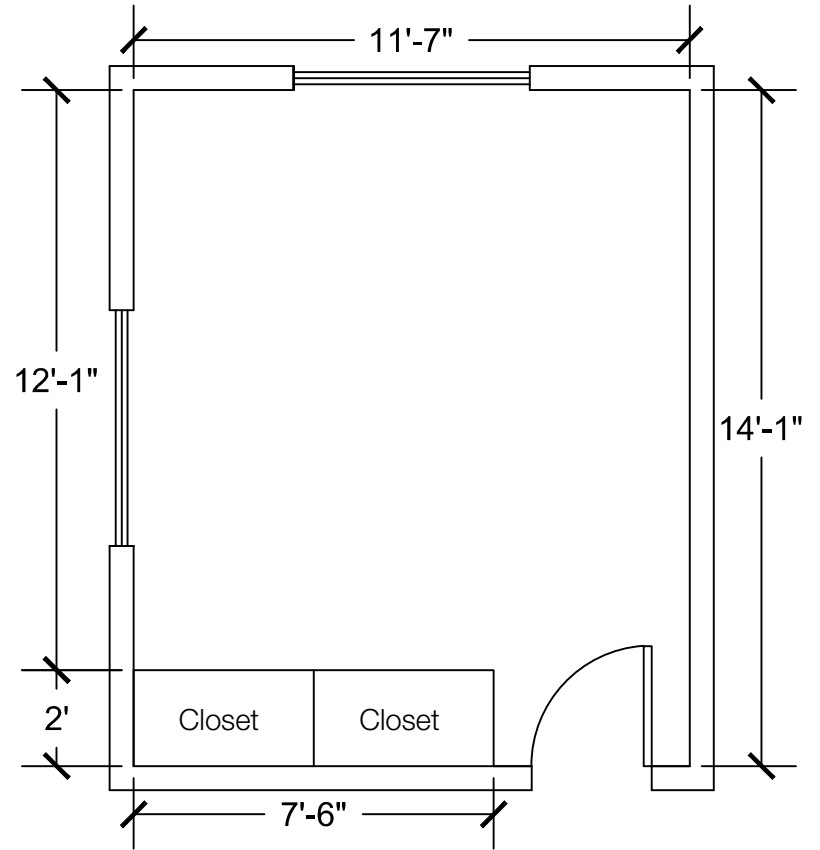
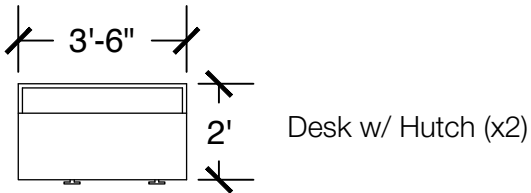
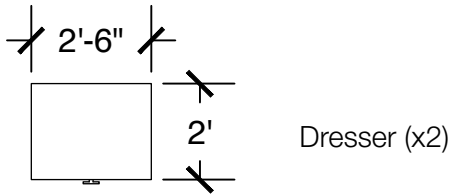
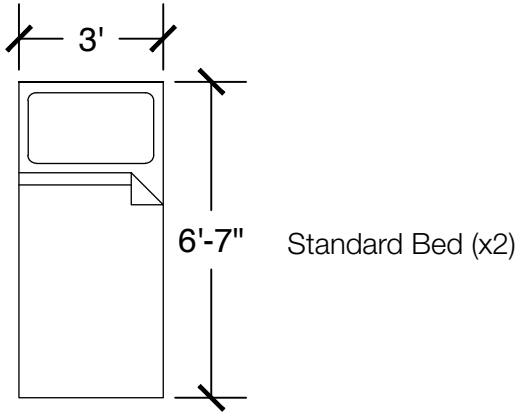

**Configuration Notes:**

Applicable to Pittman 110, 210, and 310

All drawings are 1/4"=1'-0" scale

Dimensions are meant to be general figures and may not be exact

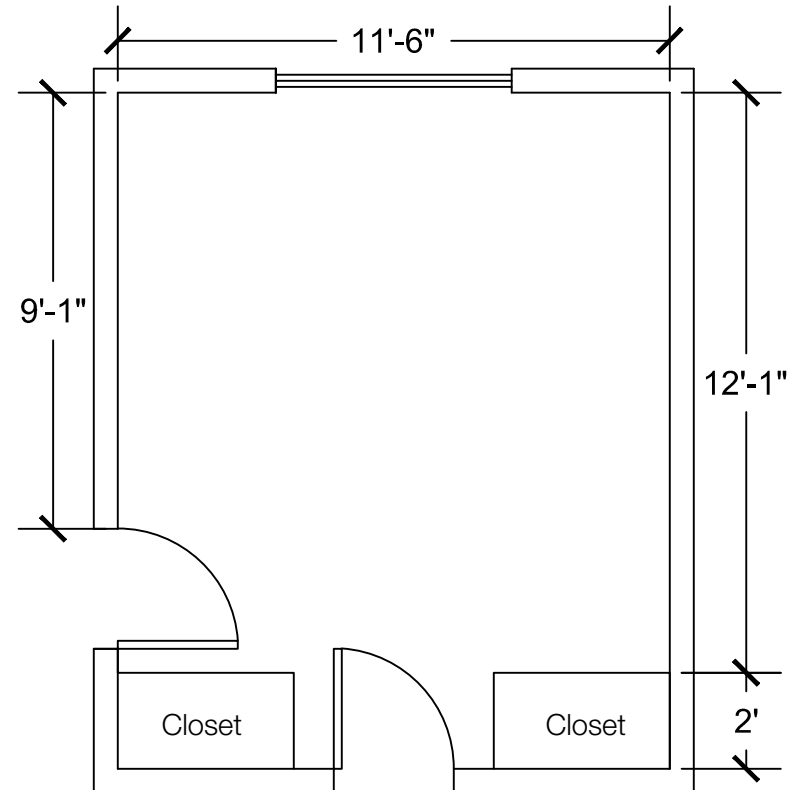
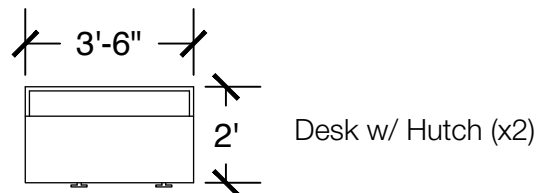
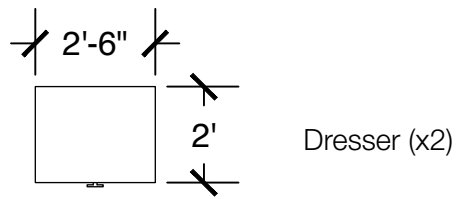
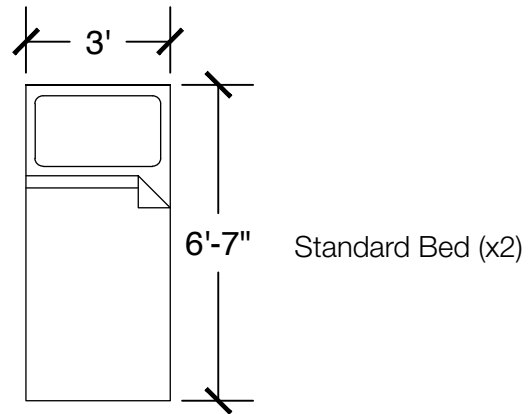

**Configuration Notes:**

Applicable to Pittman 112, 114, 212, 214, 312, and 314

All drawings are 1/4"=1'-0" scale

Dimensions are meant to be general figures and may not be exact



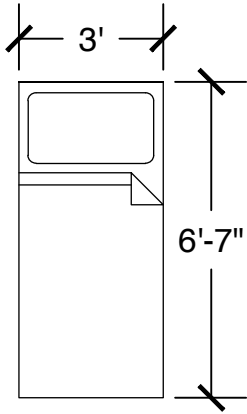

Standard Bed (x2)

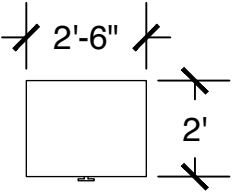

Dresser (x2)

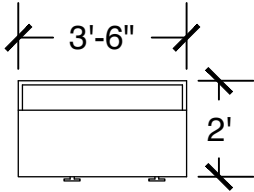

Desk w/ Hutch (x2)

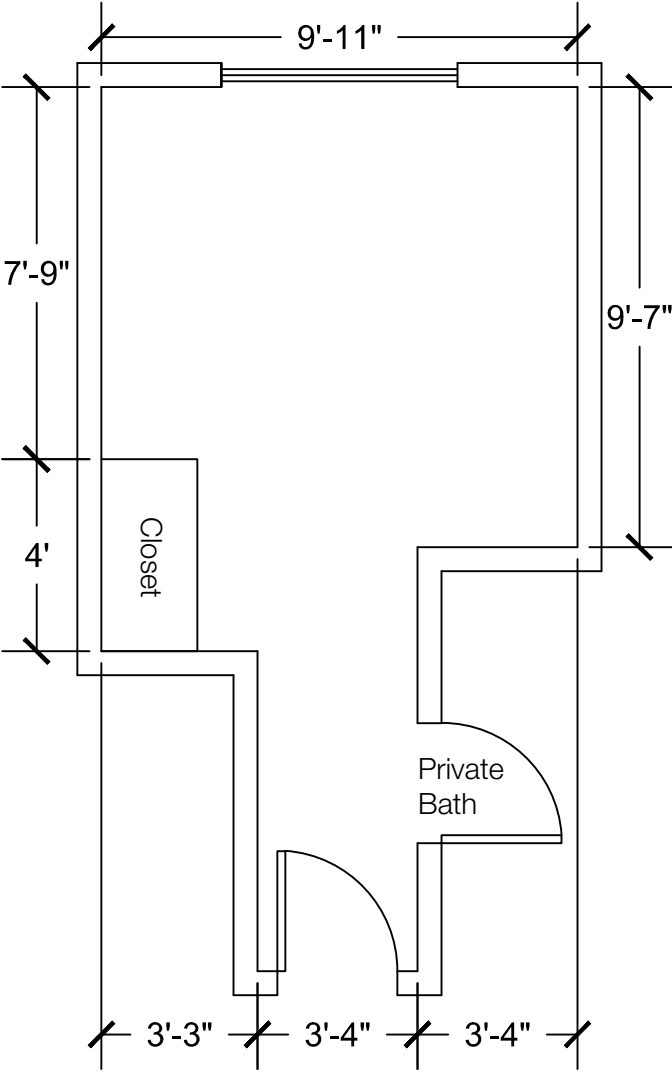

**Configuration Notes:**

Applicable to Pittman 216 and 316  
 All drawings are 1/4"=1'-0" scale  
 Dimensions are meant to be general figures and may not be exact

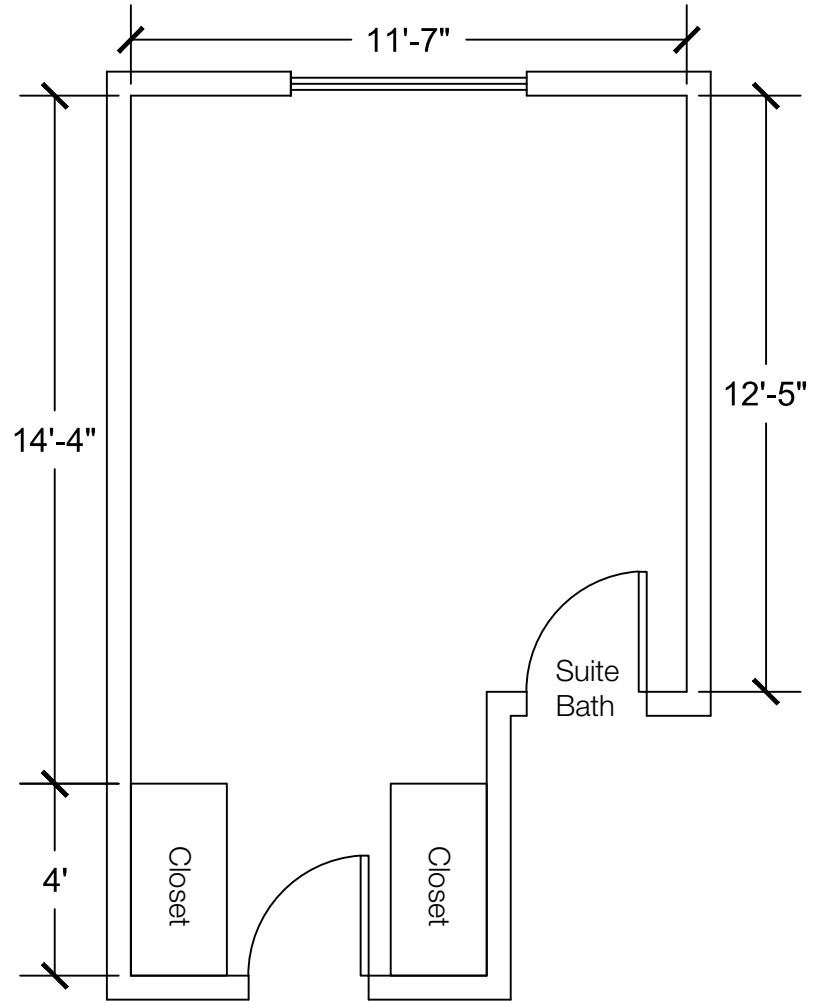
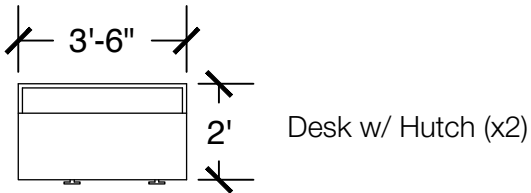
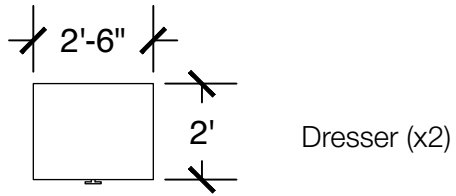
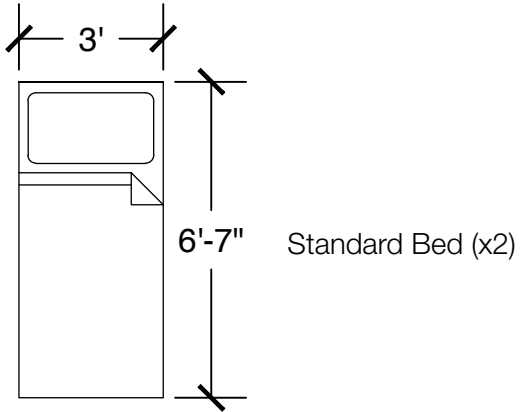

**Configuration Notes:**

Applicable to Pittman 213, 215, 217, 219, 313, 315, 317, 319

All drawings are 1/4"=1'-0" scale

Dimensions are meant to be general figures and may not be exact

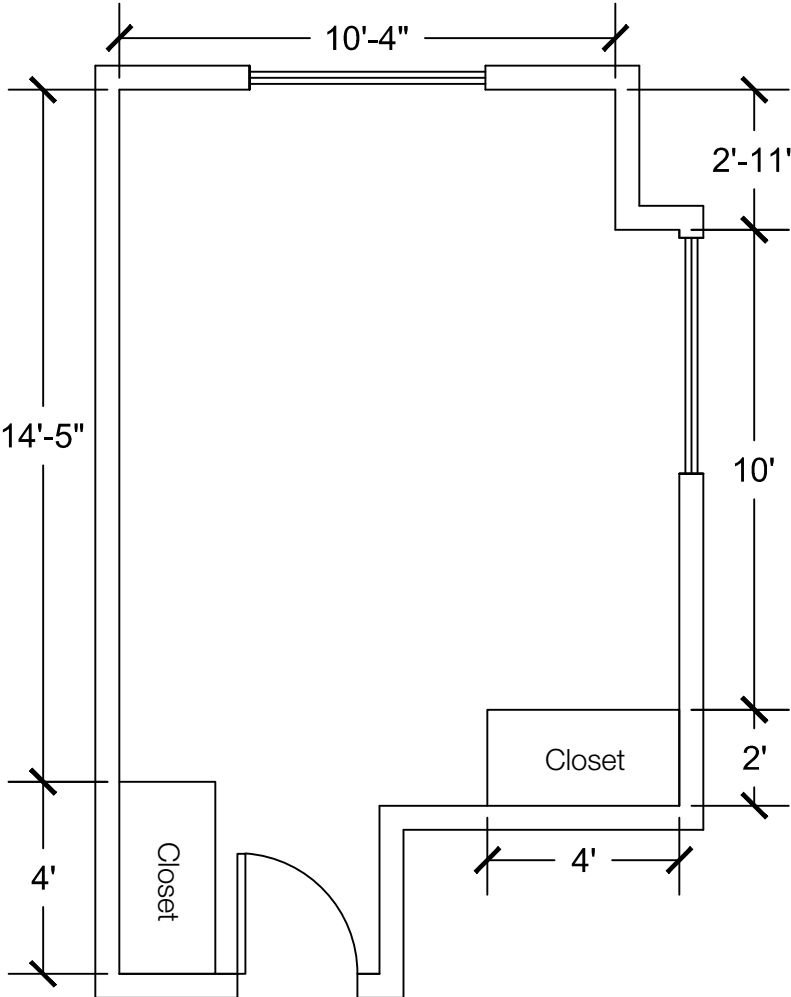
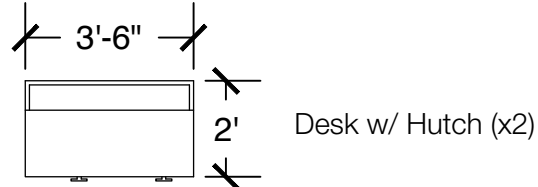
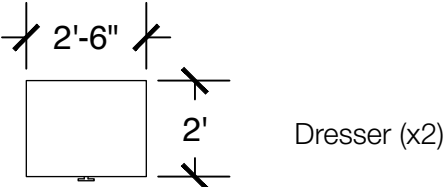
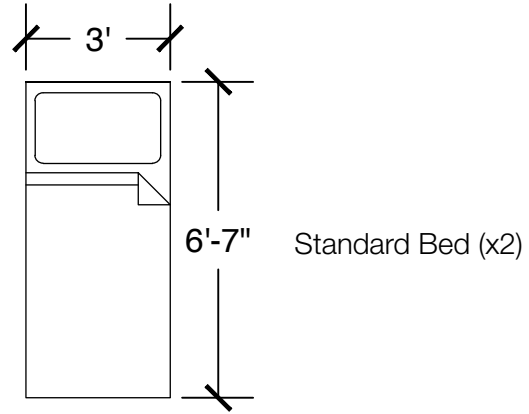

**Configuration Notes:**  
 Applicable to Pittman 321 and 328  
 All drawings are 1/4"=1'-0" scale  
 Dimensions are meant to be general figures and may not be exact

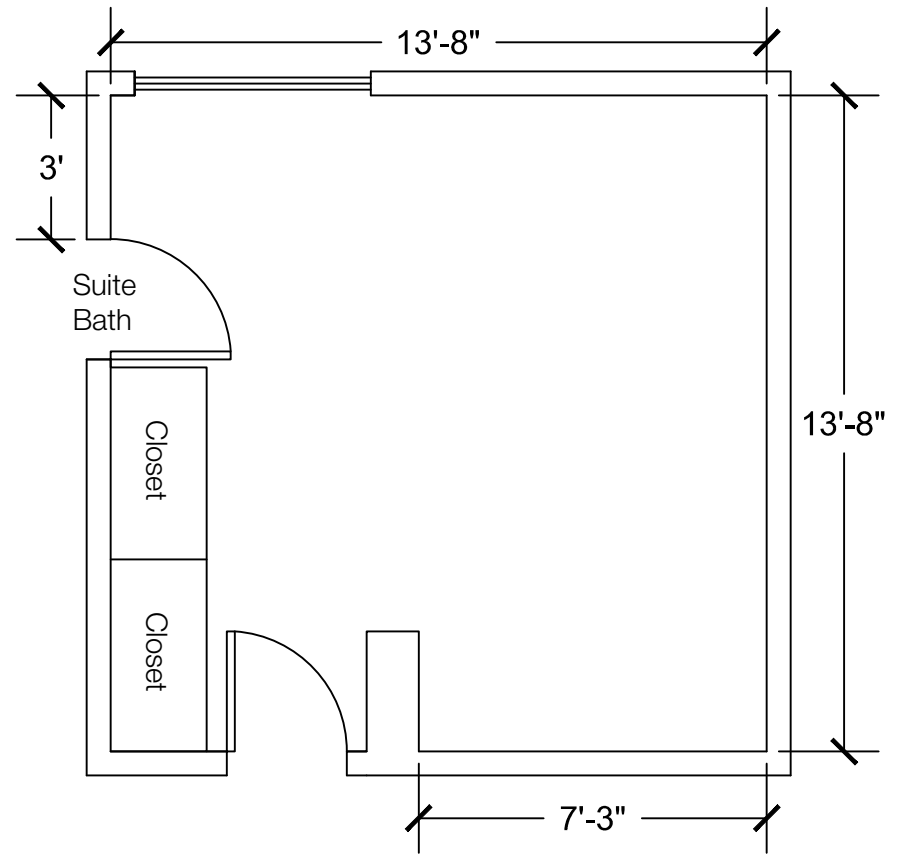
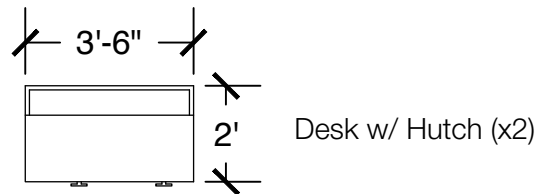
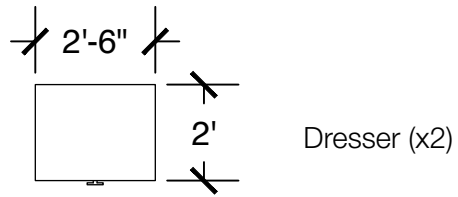
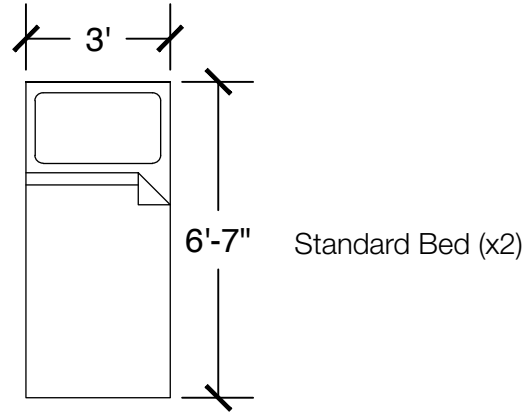

**Configuration Notes:**

Applicable to Pittman 320 and 326  
 All drawings are 1/4"=1'-0" scale  
 Dimensions are meant to be general figures and may not be exact

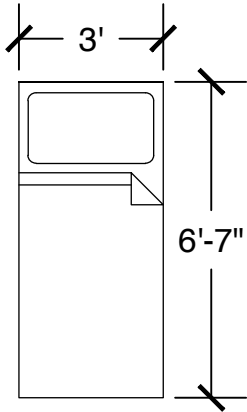

Standard Bed (x2)

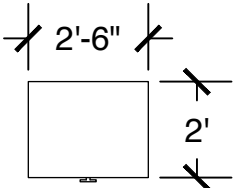

Dresser (x2)

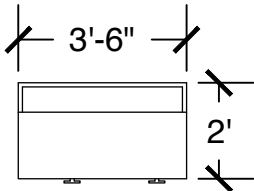

Desk w/ Hutch (x2)

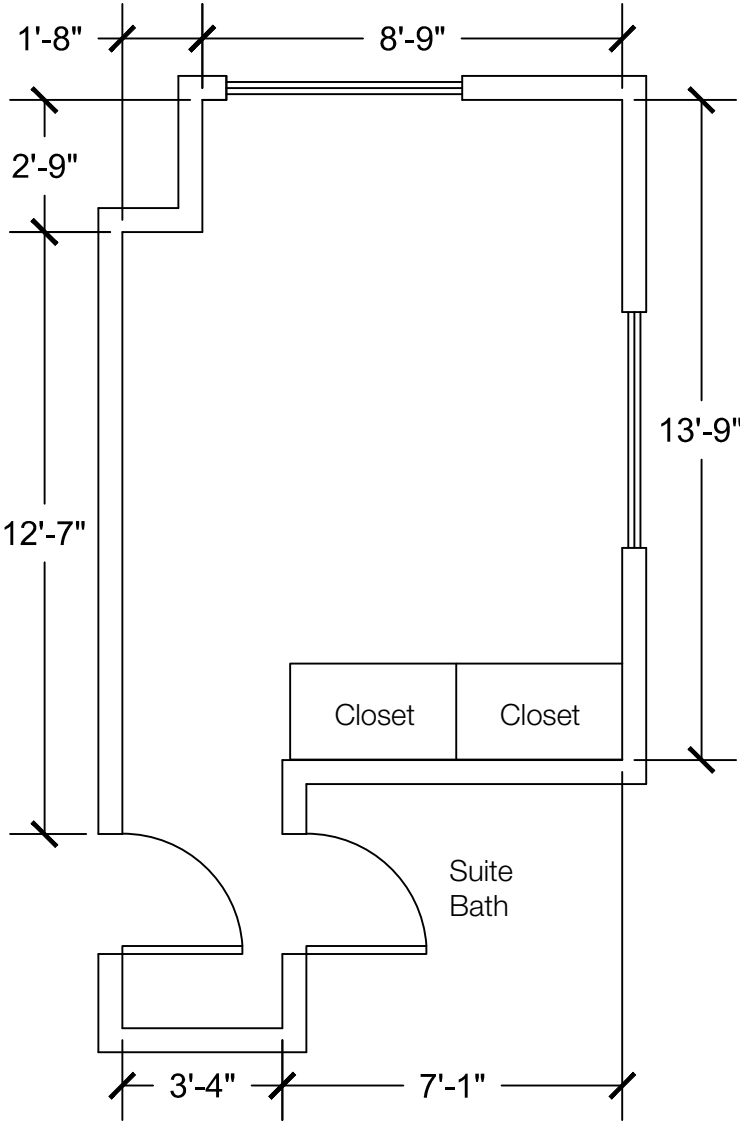

**Configuration Notes:**

Applicable to Pittman 322 and 324  
 All drawings are 1/4"=1'-0" scale  
 Dimensions are meant to be general figures and may not be exact

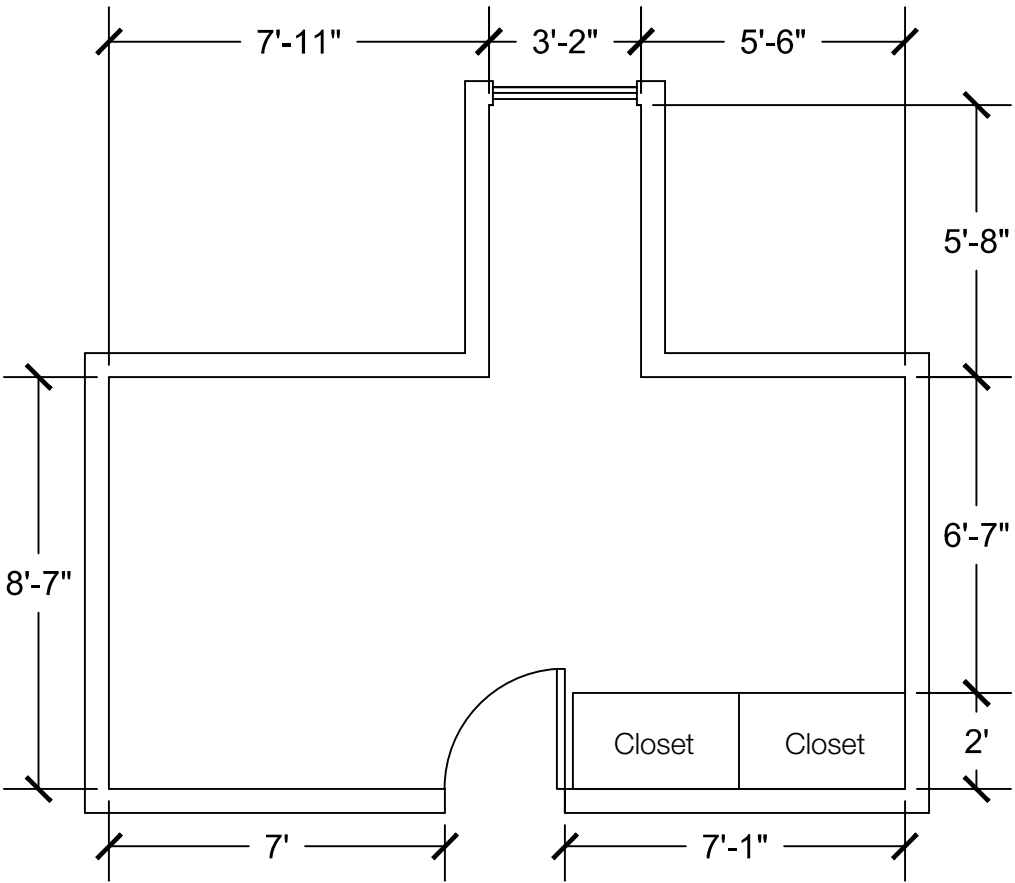
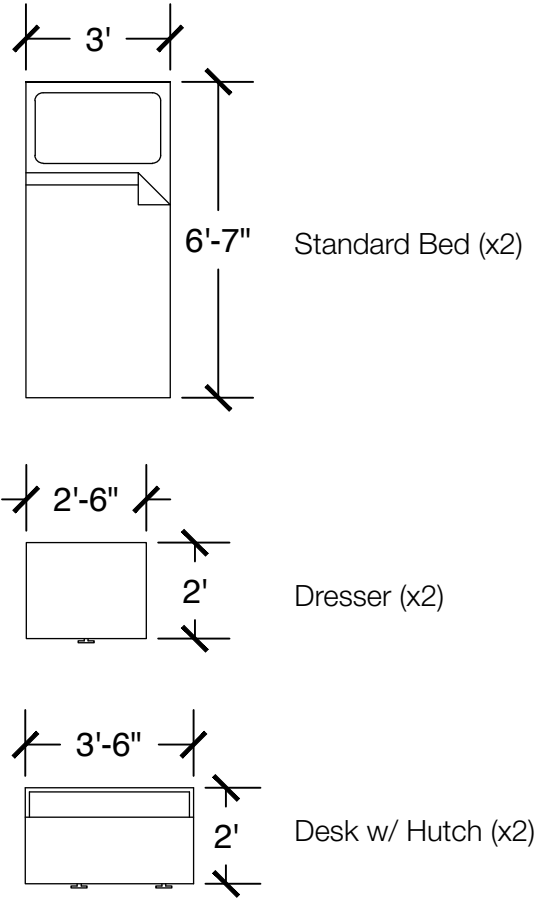

**Configuration Notes:**

Applicable to Pittman 418 and 420  
 All drawings are 1/4"=1'-0" scale  
 Dimensions are meant to be general figures and may not be exact

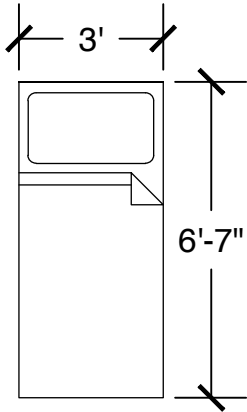

Standard Bed (x2)

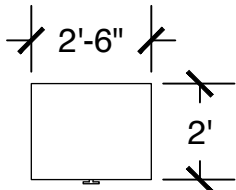

Dresser (x2)

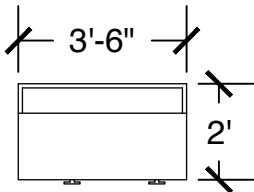

Desk w/ Hutch (x2)

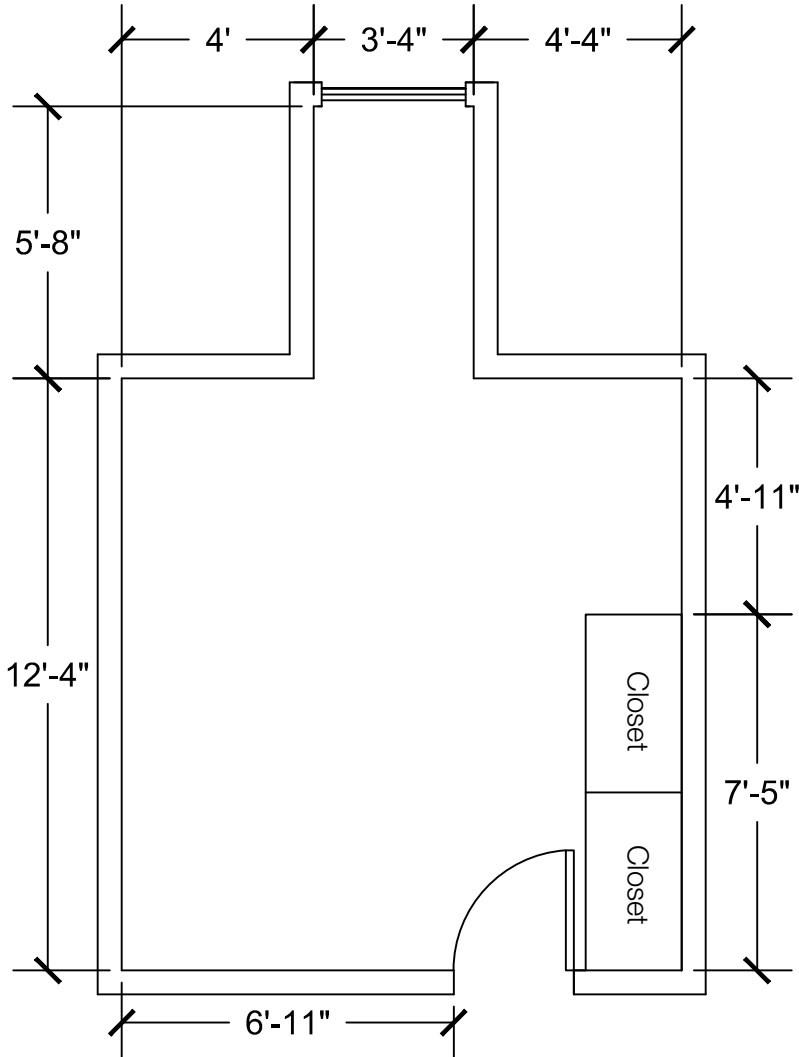

**Configuration Notes:**

Applicable to Pittman 415, 417, 419

All drawings are 1/4"=1'-0" scale

Dimensions are meant to be general figures and may not be exact